

Precalcining Systems

U. Gasser
VA 93/4055/E

1. INTRODUCTION	73
2. THEORETICAL ASPECTS OF PRECALCINING	74
2.1 2.1 Calcining of Raw Meal	74
2.2 Combustion in Precalciner	76
2.3 Specific Heat Consumption	77
2.4 True and Apparent Calcination Degree	78
3. BASIC ARRANGEMENTS OF PRECALCINING SYSTEMS	79
3.1 AS and AT Systems	79
3.2 In-Line, Off-Line and Separate Line Calciners	81
4. FEATURES OF PRECALCINERS	83
4.1 Main Benefits of Precalciner Technology	83
4.2 Limitations and Restrictions	83
4.3 Tertiary Air Damper and Kiln Riser Orifice	85
4.4 Circulation Problems and Bypass with PC Kilns	86
5. PRESENT STATE OF PRECALCINER DEVELOPMENT	87
5.1 Calciners from FCB	87
5.2 Calciners from FLS - FULLER	87
5.3 PYROCLON Calciners (KHD)	88
5.4 PREPOL® Calciners (Polysius)	88
5.5 Prerov-Calciner	88
5.6 Conclusion	89
6. SYNOPSIS OF PRECALCINERS	90
7. TEST QUESTIONS	91

SUMMARY

When burning cement clinker in a suspension preheater kiln, about 2/3 of the total heat consumed or about 2000 kJ/kg are required for the dissociation of CaCO_3 also known as calcination.

The idea of precalcination is, to let this process take place before the meal enters the rotary kiln by introducing that part of the fuel, i.e. up to 65%, into a stationary reactor.

Because the combustion air (tertiary air) is drawn through a separate duct parallel to the kiln directly from the cooler, the rotary kiln operates at significantly lower specific thermal load and gas flow.

The main advantages of precalcination are:

- ◆ More stable kiln operation due to better kiln control via two separate fuel feed/control points
- ◆ More stable kiln operation due to controlled meal conditions at kiln inlet
- ◆ Reduced thermal load of burning zone
- ◆ Higher kiln availability
- ◆ Longer life of burning zone refractories
- ◆ Larger capacity with given kiln dimensions, resp. smaller kiln for given capacity
- ◆ Possibility of increasing capacity of existing kilns
- ◆ More favorable conditions regarding circulating element problems
- ◆ Allows shorter kilns ($L/D < 12$, 2 supports)
- ◆ Lower NO_x emissions

The drawbacks of higher gas exit temperature after the bottom cyclone and the preheater higher pressure drop can be compensated by five preheater stages and modern low pressure drop cyclones.

There are three basic precalciner arrangements available from several suppliers: in-line, off-line and separate line, all with separate tertiary air duct.

Being the key for complete combustion, the main design criteria is gas retention time: 2 to 3.5 sec minimum, depending on fuel reactivity, 0.5 to 1 sec more for in-line calciners.

Systems where 10 to 20% of the fuel is introduced to the riser duct are considered secondary firings (SF) and not precalciners.

1. INTRODUCTION

The idea of separating the calcining process from the burning process was already described in a patent as early as 1912.

However, the first industrial precalciner was built by Humboldt-Wedag (KHD) only in 1966 (Fig. 1). It was the Polysius kiln in Dotternhausen (Germany) which was equipped with a special 5-stage suspension preheater with extended riser duct. This riser duct had a larger diameter and the shape of a gooseneck to provide more length thus more gas retention time enabling combustion of oilshale, a locally available fuel containing raw material. The combustion air (tertiary air) was still drawn through the rotary kiln. Additional burners were installed later at the bottom of the precalciner chamber.

Tube type calciners using the gooseneck design are still being used by KHD (Pyroclon) and Polysius (Prepol).

So it is obvious that the precalciner (PC) kiln was developed from a straight suspension preheater (SP) kiln. The process characteristics (heat balance etc.) of both SP and PC kiln systems are quite similar, the main difference being the fact that in case of the PC kiln, 50 to 60% of the fuel (heat) is introduced via a chamber between kiln inlet and bottom cyclone. This allows to match the process heat requirements more evenly leading to significant improvements.

Since true precalciners with 50 to 60% PC fuel ratio require a separate tertiary air duct, almost all PC kilns feature a grate cooler.

The demand for larger and larger capacities which started back in the 1970ies led to a rapid development of the new precalciner technology. The fastest growing market asking for the largest units was in Japan where most of the clinker is produced in PC kilns.

During that period, 12 competing suppliers developed their own precalciners, 8 of them were Japanese (see para „synopsis of precalciners“).

After the home market for cement plants started to stagnate, the Japanese suppliers exported their know-how via licenses as well as entire plants. During the late 1980ies, where only few new plants have been constructed world-wide, the Japanese activities came to a stop.

The latest development of precalciner technology was aimed at

- ◆ Complete combustion, also for low reactivity fuels
- ◆ Suitability for a wide range of fuels
- ◆ Low emissions of NO_x

Since the Japanese competitors have virtually disappeared on the international market, the variety of precalciner systems is reduced. Five European suppliers (FCB, FLS-Fuller, KHD, Polysius and Prerov) offer precalciners, some even a choice of alternative solutions.

2. THEORETICAL ASPECTS OF PRECALCINING

2.1 2.1 Calcining of Raw Meal

Among all reactions taking place when burning clinker, the calcining - also called decarbonisation - requires the highest amount of energy: the dissociation of carbonates, primarily calcium carbonate according to the reaction

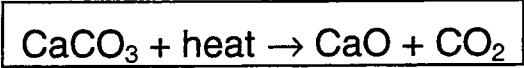

in the raw meal requires approx. 1.3 MJ/kg raw meal corresponding to 2.0 MJ/kg cli. The DTA-curves (Fig. 2) illustrate very well the importance of calcining within the clinker burning process.

Fig. 2 Differential Thermo-Analysis (DTA)-curves of a typical cement raw meal

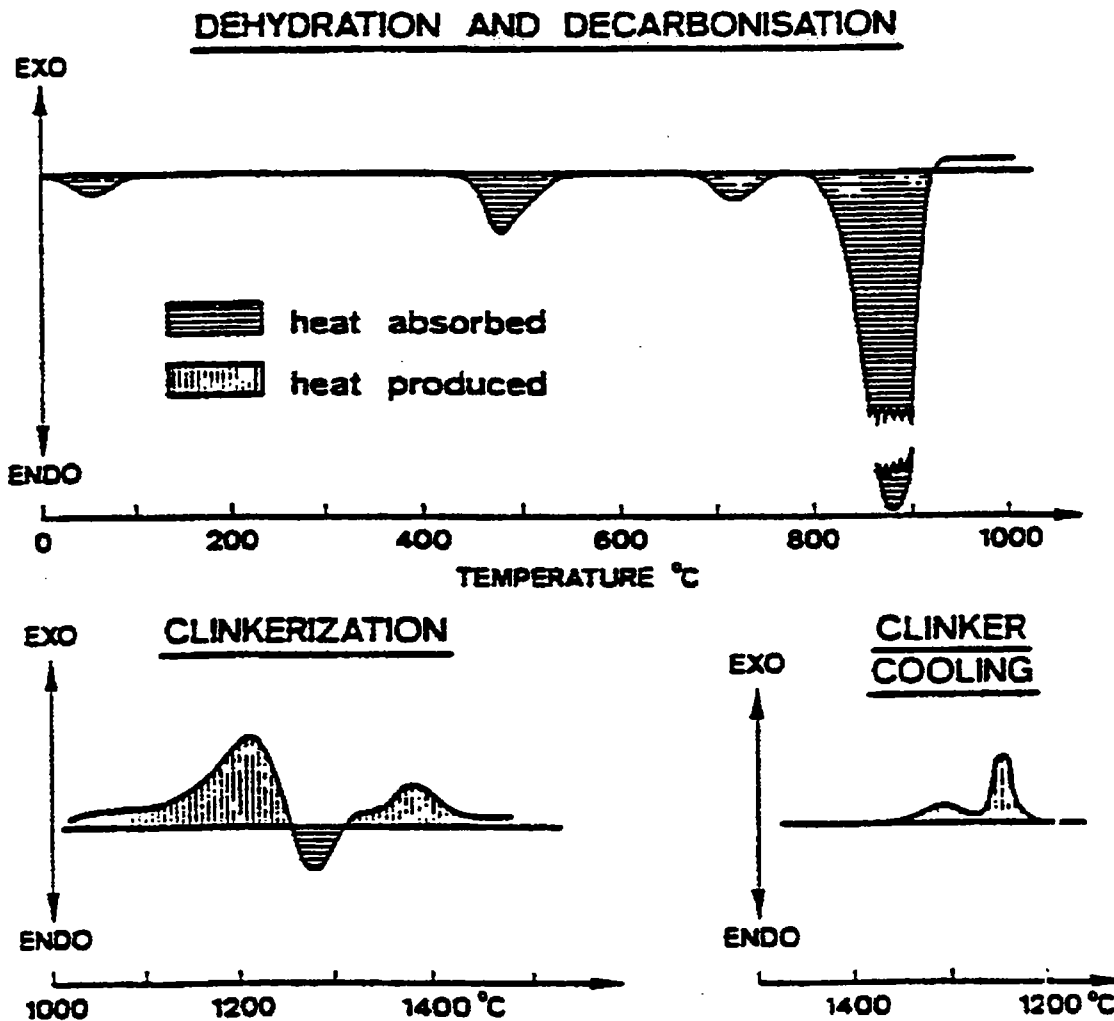

During the process of heating up a raw meal, the calcining does not happen suddenly at a well defined temperature, but starts at about 600 - 700°C and ends between 900 and 1000°C, following a so-called „S curve“ (Fig. 3). Exact shape and position of this curve vary from raw meal to raw meal.

Fig. 3 General aspect of the calcining curve of a cement raw meal

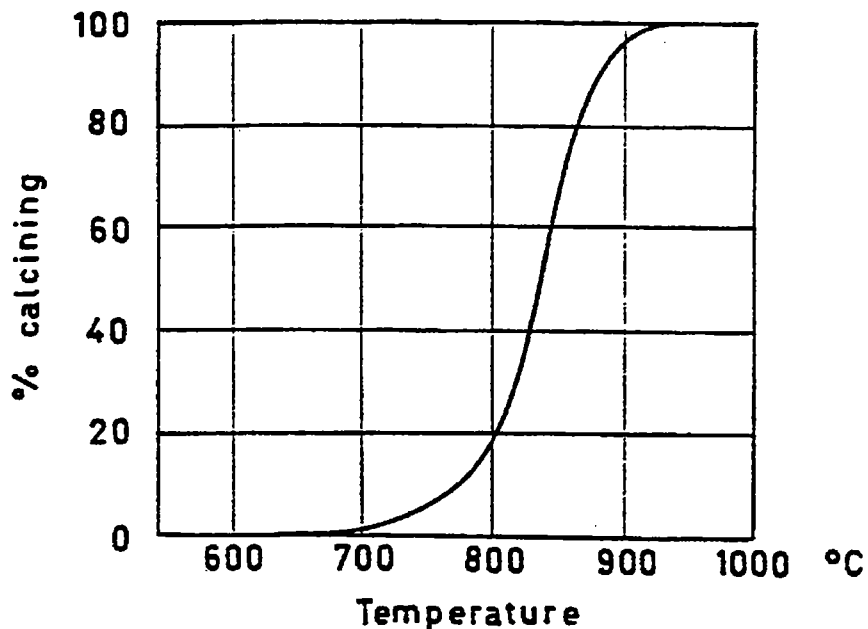
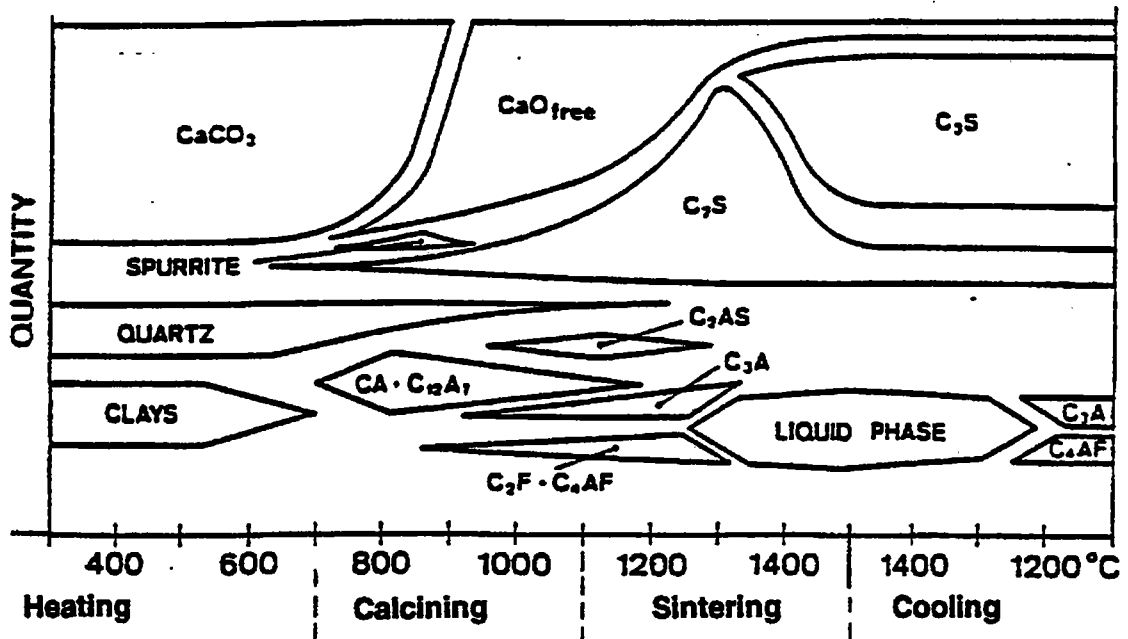

Not only the temperature, but also the retention time of the raw meal is an important parameter of calcining. While the heat transfer from gas to suspended raw meal in a preheater stage is achieved a fraction of a second, the complete calcination at a temperature of about 900°C in suspension requires a reaction time in the range of 2 to 12 seconds. However, as only 90 to 95% of the calcining should take place in the precalciner in order to avoid clogging problems, a residence time of about 1 to 3 seconds has proven to be sufficient.

To perform both above mentioned tasks, i.e. to keep raw meal in suspension for a few seconds at 850 to 900°C in a stationary vessel without clogging, is the common process target of all PC systems.

2.2 Combustion in Precalciner

The combustion in the precalciner takes place under quite different conditions compared to the main firing because:

- ◆ The temperature of the combustion environment is in the order of 850 to 900°C (flame temperature of the main firing: around 2000°C).
- ◆ Some PC systems (in-line systems) use an air-gas mixture for combustion (main firing: pure primary and secondary air) while others use pure air (off-line and separate line systems).
- ◆ In all PC systems preheated raw meal is suspended in the combustion air or air-gas mixture respectively in order to absorb the heat released thereby maintaining the temperature at a comparatively low level. By all means must Sintering of material avoided, as this would lead to clogging in the precalciner stage.

On the account of the less favorable combustion conditions complete combustion is not always readily obtained, it requires a certain experience to achieve optimum performance. Of the various parameters influencing the combustion performance, the following are perhaps the more important ones:

- ◆ Good mixing of the fuel with the available oxygen. (This is particularly difficult to achieve with in-line calciners.) Optimum fuel dispersion into the gas flow (liquid fuel: atomization) is essential.
- ◆ Retention time for combustion has to be sufficient. The combustion must be completed in the PC stage. Otherwise, it will continue in the next stage (post-combustion) where the temperature level is lower and therefore less favorable for the calcination (see S-curve). This results in not optimum utilization of the heat which leads eventually to higher fuel consumption.
- ◆ The flow pattern of the air/gas mixture (resp. tertiary air) has to be favorable for the combustion.
- ◆ The meal distribution in the combustion zone has to be optimum, i.e. causing minimum distortion of the combustion. (CaCO₃ as well as CO₂ can also react with C - carbon from the fuel - to produce CO!).

It is known from experience that too high concentrations of raw meal can seriously impede the complete combustion.

With the introduction of the separate air duct for the combustion air for the calciner, the new term of tertiary air had to be introduced:

Primary air:	Air introduced via kiln burner
Secondary air:	Air from cooler to kiln burning zone
Tertiary air:	Air from cooler to PC for combustion

Introduction of fuel between kiln inlet and bottom cyclone - as secondary firing or via precalciner - necessarily increases the temperature level. The gas exit temperatures from the lowest stage of a straight preheater kiln is only 790 to 820°C as compared to precalciner kilns where this temperature increases by some ten degrees to 840 to 870°C. Therefore, the preheater exit temperature is also somewhat higher entailing an increased heat loss, which is more pronounced with 4-stage preheaters.

The performance of PC systems can primarily be judged on two characteristic values:

- ◆ The temperature difference between gas and material ex precalcining stage should be as low as possible, so as to minimize the heat losses of the exit gas. The reaction temperature in the precalciner depends of course on the raw meal and the required precalcining degree as well as tolerated NOx level.
- ◆ Complete combustion must be achieved as this directly influences the overall heat consumption of the system. It must be mentioned that this is strongly influenced by the excess of air.
 - Note: Stating the amount of unburned matter in the gas is therefore only meaningful to assess a calciner system, if the amount of oxygen in the gas is indicated as well.

Solid, liquid and gaseous fuels are successfully fired in PC kiln systems. However, the location and position of the burners in the precalciners have to be adapted to the fuel particularities. This is specially important for gaseous fuels, which seem to be more difficult to burn in the PC chamber than other fuels.

2.3 Specific Heat Consumption

From the above mentioned it can be concluded that PC systems have a tendency to slightly increased heat consumption, unless countermeasures are taken such as:

- ◆ Although equipping existing preheater kilns with precalcination usually results in a slight increase of the heat consumption, the average (annual) heat consumption may be equal or even lower on account of a more regular kiln performance.
- ◆ Also for new installations the heat consumption is about 50 - 100 kJ/kg cli higher than for conventional preheater kilns with 4 stages.

Where the somewhat higher exit gas temperature cannot be fully used, say for raw material drying - then it has become standard to install one or two additional preheater stages to reduce the heat consumption to a figure slightly, for 6 stages noticeably, below that of a conventional 4st SP kiln. The first PC kiln in Dotternhausen was in fact equipped with a 5-stage preheater.

2.4 True and Apparent Calcination Degree

An important parameter for controlling the precalciner operation is the calcination degree. It is important to know the meaning of the true and the apparent calcination degree.

True calcination degree:

Degree to which the calcination is completed, i.e. extent to which the CO_2 is dissociated from the $CaCO_3$.

<u>Extremes:</u>	Raw meal	0% (LOI = 35%)
	Clinker	100% (LOI = 0%)

In reality, the calcination degree is determined using a hot meal sample taken from the meal duct of the bottom cyclone. Because of always present dust cycles between kiln / kiln inlet / kiln riser / bottom cyclone, this sample contains a certain amount of dust which was already in the kiln calcining zone and is higher or even fully calcined. This sample is therefore a mixture consisting of „fresh“ meal and dust circulated back and has a higher calcination degree than the pure „fresh“ hot meal.

This means: The higher the dust concentration near the kiln inlet resp. the dust cycle, the higher the apparent calcination degree.

Apparent calcination degree:

The calcination degree determined from a hot meal sample taken from the meal duct of the bottom cyclone.

Fig. 5 True and Apparent Calcination Degree, PC Fuel, Dust

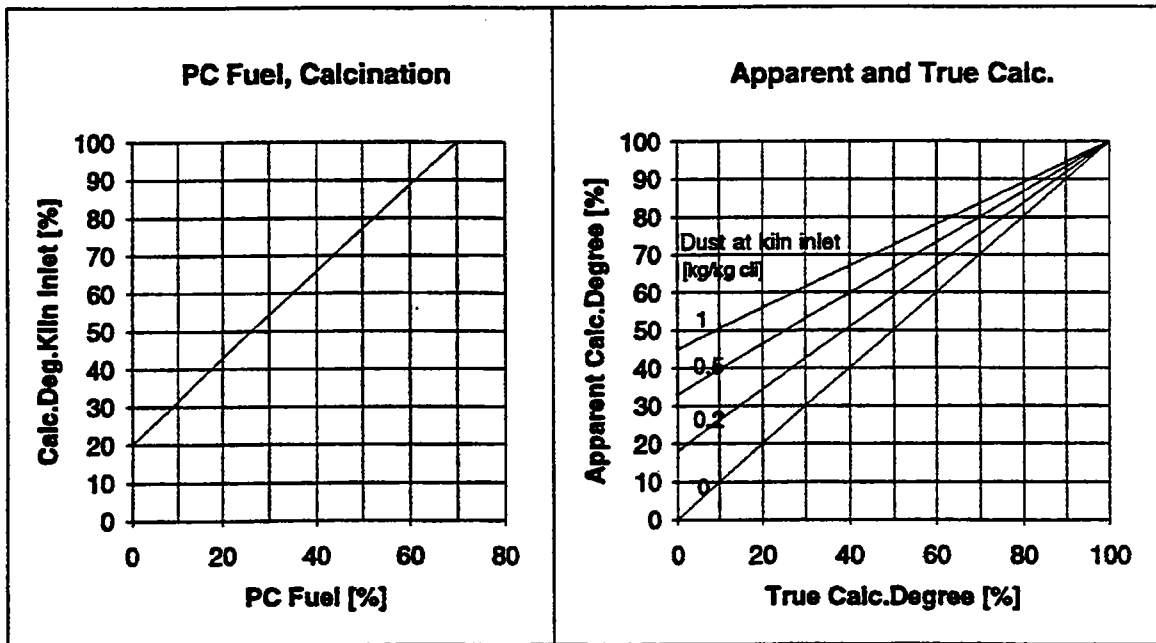

3. BASIC ARRANGEMENTS OF PRECALCINING SYSTEMS

3.1 AS and AT Systems

The first precalciner in Dotternhausen used combustion air which was drawn through the kiln as excess air. This technology was maintained for several years and is known as AT System. However, in reality only up to 35% fuel could be introduced to the precalciner thus limiting its benefits. The AT type is thus no longer considered a precalciner; it is rather used for secondary firings where a high calcination degree at the kiln inlet is not the main target.

Fig. 7 AS and AT Systems

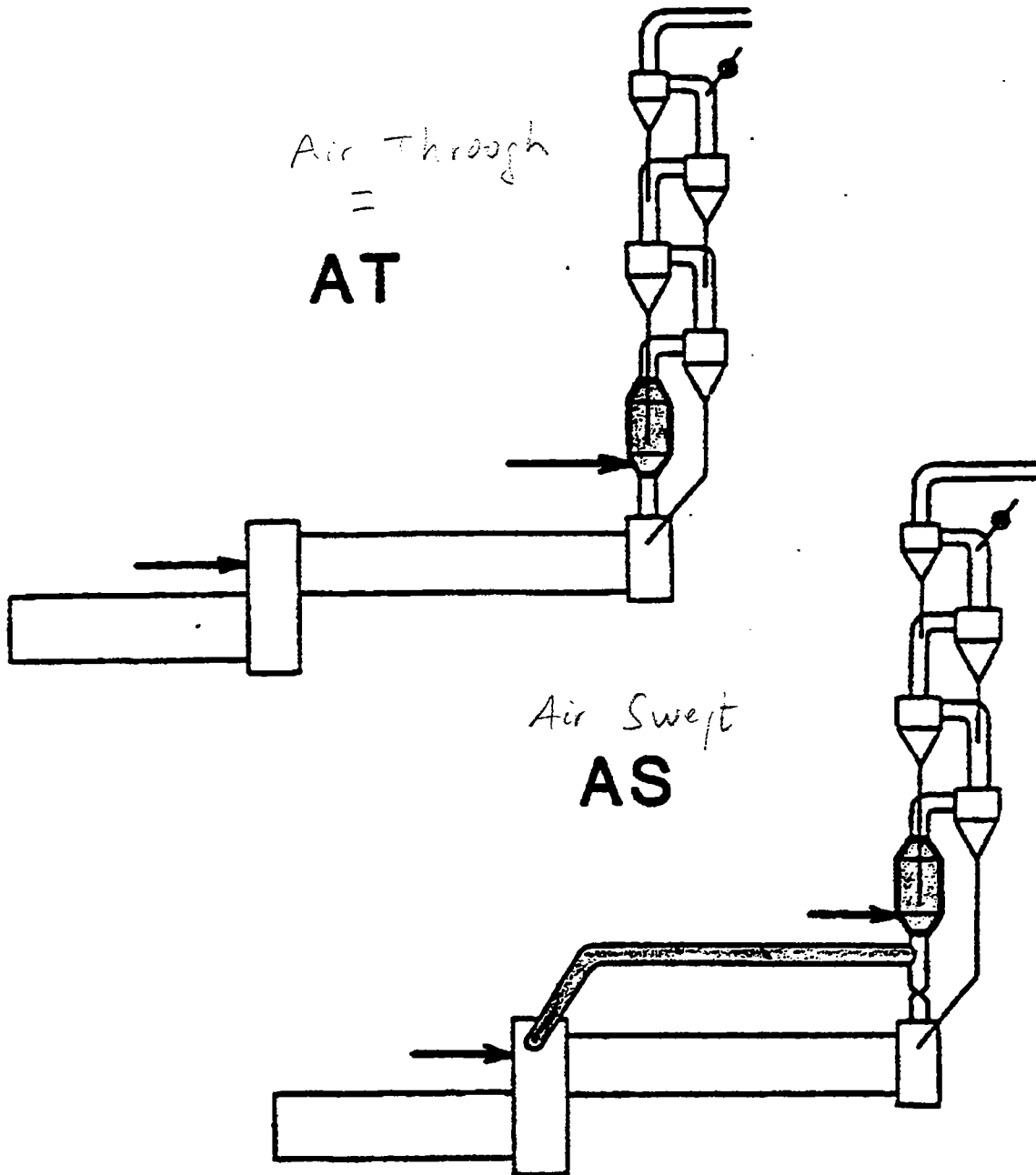

Today, all precalciners are AS Systems using tertiary air which is extracted from the kiln hood or from the cooler roof and drawn via a separate tertiary air duct parallel to the kiln to the precalciner. This means that planetary coolers are not compatible with precalcination technology (i.e. AS systems).

Table 1 Comparison of AS and AT System

Item	AS	AT
Portion of fuel to the precalciner	up to 65%	max. 35%
Largest kiln in operation	8500 t/d, ϕ 6.2 x 105 m	4700 t/d, ϕ 5.2 x 80 m
Kiln ϕ for given capacity (st SP = 100%)	approx. 75-80%	approx. 85-90%
Suitable type of cooler	only grate or rotary	all types
Suitable for extension of existing SP kiln	poor (cooler, tertiary air duct)	very good for low PC rates
Burning conditions in rotary kiln	normal flame temperature (normal excess air)	lower flame temperature and stable operation due to high excess air
Thermal load in burning zone (4st SP = 100%)	approx. 60-70% at 60% PC	approx. 85-90% at 30% PC
Behavior regarding circulating elements	like 4st SP kiln	due to the high O ₂ -content of the kiln atmosphere, reduced volatility of sulfur and therefore decrease of encrustation in transition zone and riser pipe
Heat loss at 10% bypass (4st SP = 100%)	approx. 40% (bypass will be smaller than in 4st SP kiln)	approx. 90% (bypass will have same size as in 4st SP kiln)
Exhaust gas temperature (4st preheater)	higher than 4st SP	higher than 4st SP
Heat consumption	slightly higher than 4st SP	slightly higher than 4st SP
Pressure loss over preheater	higher than 4st SP	slightly higher than 4st SP

$T_{max}^{preheater} = 260^{\circ}C \approx 230^{\circ}C$

3.2 In-Line, Off-Line and Separate Line Calciners

This criteria refers to the position of the precalciner in the kiln system installation and is illustrated with Fig. 8 below.

- ◆ In-Line Calciners are installed in the kiln exhaust gas flow which means that the combustion takes place in an air/kiln gas mix. This precalciner can be considered an enlarged kiln riser duct.
- ◆ Off-Line Calciners are installed off the kiln exhaust gas flow. The combustion takes place in pure (tertiary) air which is also responsible for lifting up the meal.
- ◆ Separate Line Calciners are off-line calciners with a separate preheater string.

Fig. 8 Precalciner Arrangements

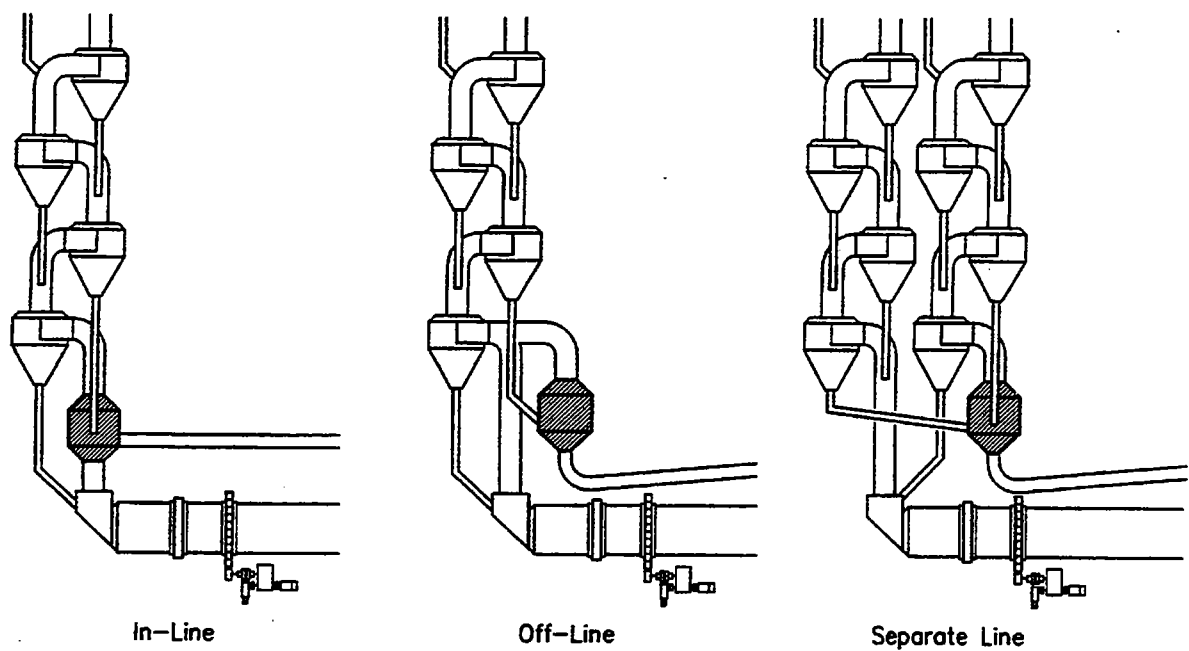

Table 2 Comparison of Calciner Arrangements

	In-Line	Off-Line	Separate Line
PC arrangement	Extended riser duct	Parallel to riser duct	Parallel to riser duct
Combustion atmosphere	Kiln gas and air mix	Pure air	Pure air
Preheater string	1 to 4 of same size	1 to 4 of same size	2 to 4, 2 different sizes
Advantages	Low NOx version (reducing kiln NOx)	Suitable for modification	Two independent combustions → Easy combustion control
	Excess air used for combustion	Good combustion	Good combustion
Weak points	Suitable for lump fuel	Suitable for modifications	Suitable for modifications
	Mixing of air with gas	Higher peak temperature (NOx!)	Higher peak temperature (NOx!)
	Larger volume required	PC drop-out can fill TAD	PC drop-out can fill TAD
	Incomplete combustion		Asymmetry regarding circulating elements
	Height requirement (depending on type/design)		Requires 2 strings (not feasible for <3000 t/d) Strings of different sizes (problem >7000 t/d)

4. FEATURES OF PRECALCINERS

4.1 Main Benefits of Precalciner Technology

There are many advantages of precalciner technology which made it state of the art today. Some of them are listed here:

- 1) More stable kiln operation due to better kiln control via two separate fuel feed/control points.
- 2) More stable kiln operation due to controlled meal conditions at kiln inlet.
- 3) Reduced thermal load of burning zone.
- 4) Lower brick consumption as a result of 1. and 3.
- 5) More than double capacities possible with given kiln (10'000 t/d with 6 m x 95 m kiln).
- 6) Possibility of increasing capacity of existing kilns.
- 7) Reduced volatilization of circulating elements.
- 8) Reduction of cycles (S, Cl, Na₂O, K₂O) with smaller bypass rate, i.e. lower losses.
- 9) Makes short kilns possible with 2 stations, L/D < 12
- 10) Possibilities of NO_x reduction.
- 11) Lump fuel utilization in some cases.

4.2 Limitations and Restrictions

Even though the advantages of precalciner systems are doubtlessly convincing, not all types can be used in all cases. Limitations are:

- ◆ Additional installation (fuel dosing, calciner, tertiary air duct) as well as the relatively smaller rotary kiln sets a lower economical limit to PC systems for new plants at around 1200 t/d.
- ◆ Alternative fuels containing hazardous components can only be used in the main firing due to the high temperature level there. The potential to use such fuels is then lower for PC kilns.
- ◆ Higher exhaust gas temperature and higher pressure drop can be a drawback in specific cases.
- ◆ Separate line calciners for new installations are only feasible if a 2-string arrangement is required for the capacity, i.e. above 3500 t/d.

Fig. 9 Comparison of wet, SP and PC Kilns (average curves)

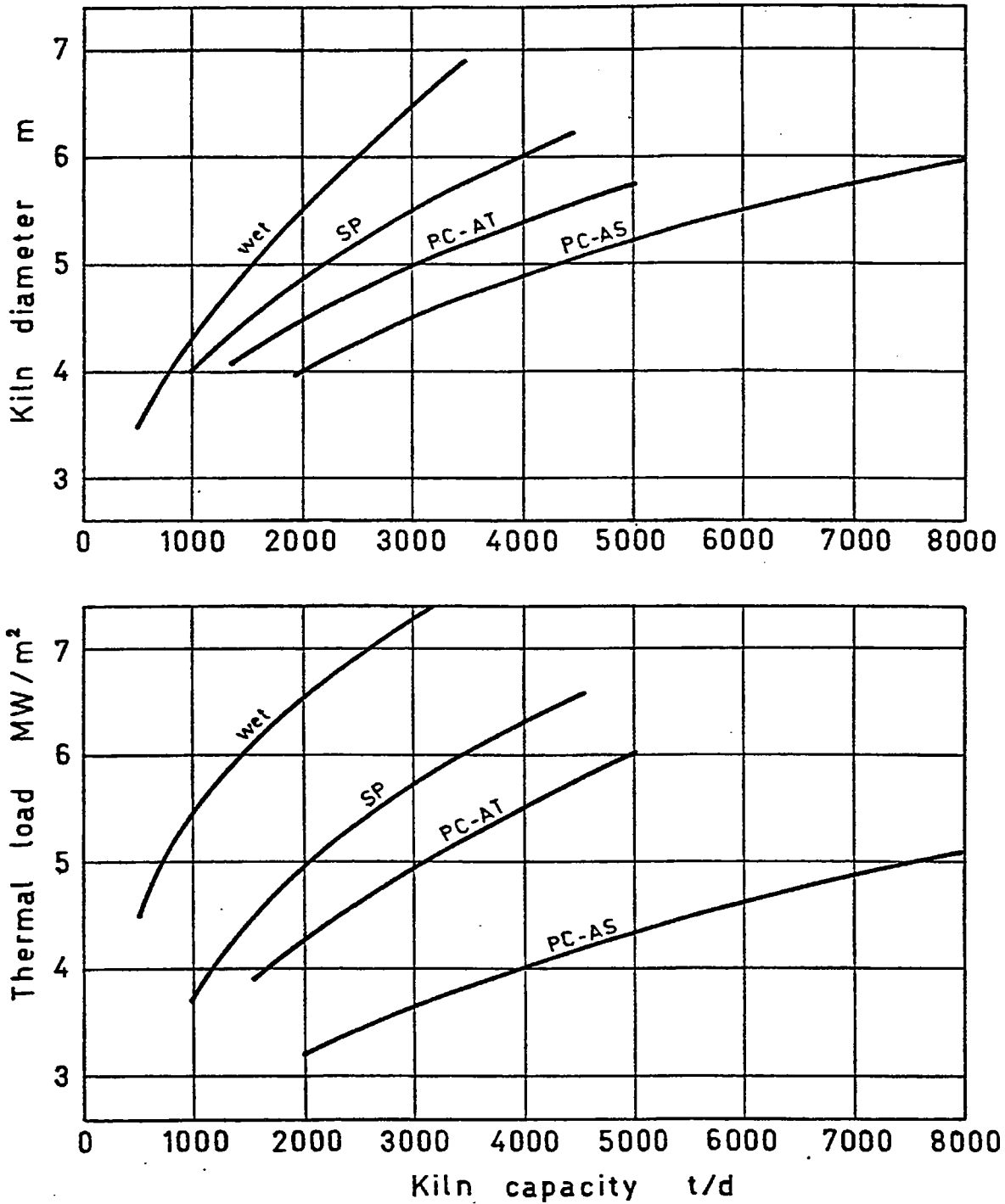

4.3 Tertiary Air Damper and Kiln Riser Orifice

Off-line calciners as well as in-line calciners are usually equipped with one kiln ID fan. In order to allow control of the tertiary air/secondary air ratio, there must be a control device in at least one of the two gas paths (kiln resp. tertiary air duct).

For efficient warming up of the preheater, a damper is usually installed in the tertiary air duct to avoid fresh air to bypass the main flame. Very often, this damper is used also, for controlling the tertiary air flow (Fig. 10a). However, experience shows that high temperature and clinker dust require a quite refined design of this tertiary air damper. In many cases, this damper operates only for a short period without problems.

Another approach is to install the control device in the other path. Some suppliers (e.g. FLS and Kawasaki) have developed a kiln riser orifice which is successfully operating in several plants. This solution (Fig. 10b) is generally more expensive than the TA damper above, but performs well.

Fig. 10 **TA Damper and Kiln Orifice**

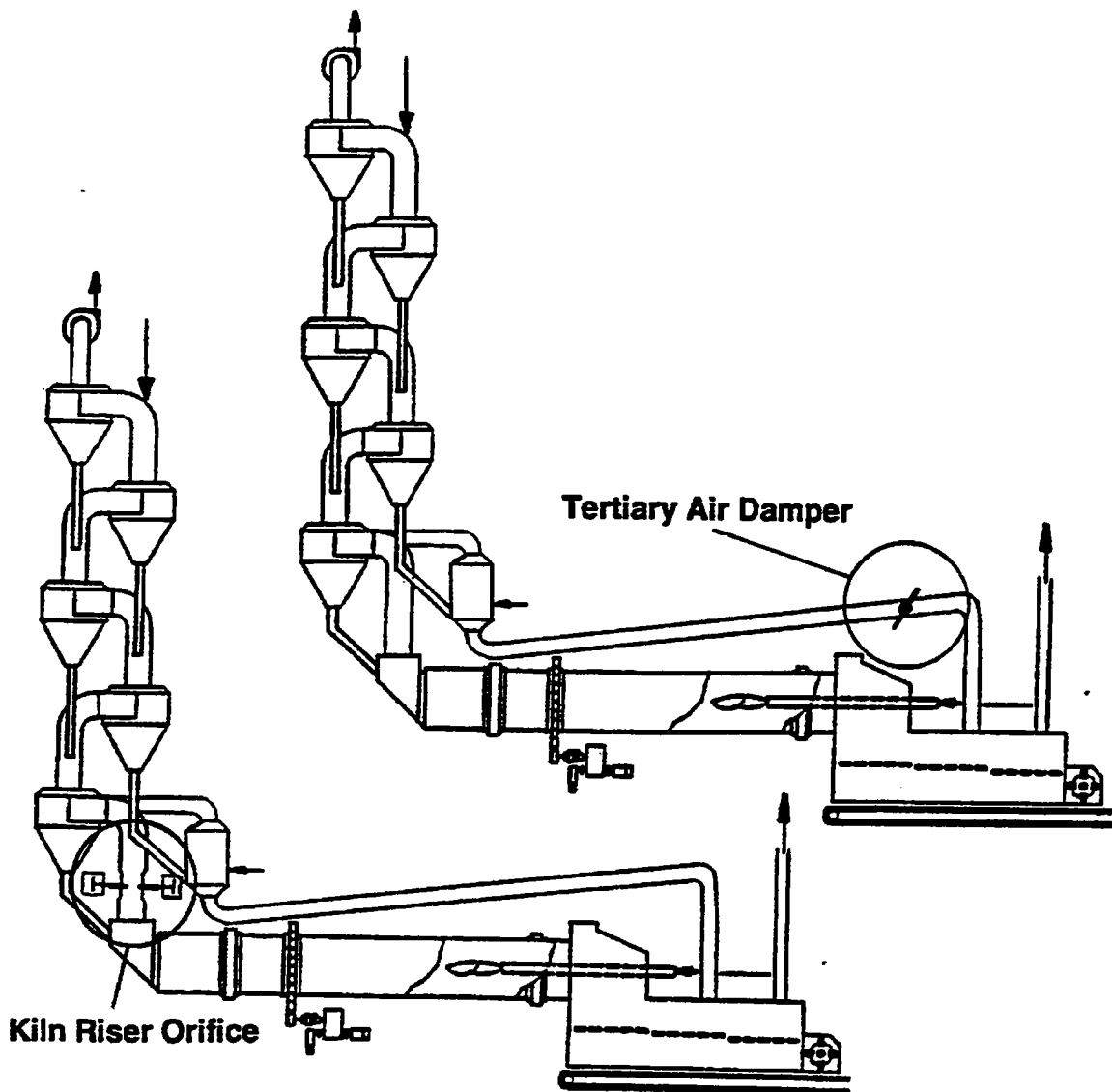

4.4 Circulation Problems and Bypass with PC Kilns

Precalciner kiln systems have two major advantages regarding circulation problems.

- ◆ Reduced volatilization in the rotary kiln because less than 50% of the heat is introduced in the burning zone.
- ◆ Less than 50% thermal and dust losses in case of a bypass compared to a straight SP kiln.

The volatilization of circulating elements occurs primarily in the rotary kiln. The percentage of the volatilized elements which can be extracted with a bypass depends on

- ◆ volatilization rate in the kiln, and
- ◆ amount of kiln gas extracted via bypass (= bypass rate) which is expressed by the ratio:
$$\frac{\text{bypass gas}}{\text{gas at kiln inlet}}$$

The highest possible reduction of circulating elements at a given volatilization rate would be if 100% of the gases at the kiln inlet could be extracted. This is only possible in the case of a precalciner but not with a straight preheater kiln. Accordingly are the heat losses approx. 50 to 60% lower at a given reduction because the concentration of volatilized circulating elements in the gas at the kiln inlet is much higher than for a SP kiln.

Fig. 11 Bypass for PC Kilns

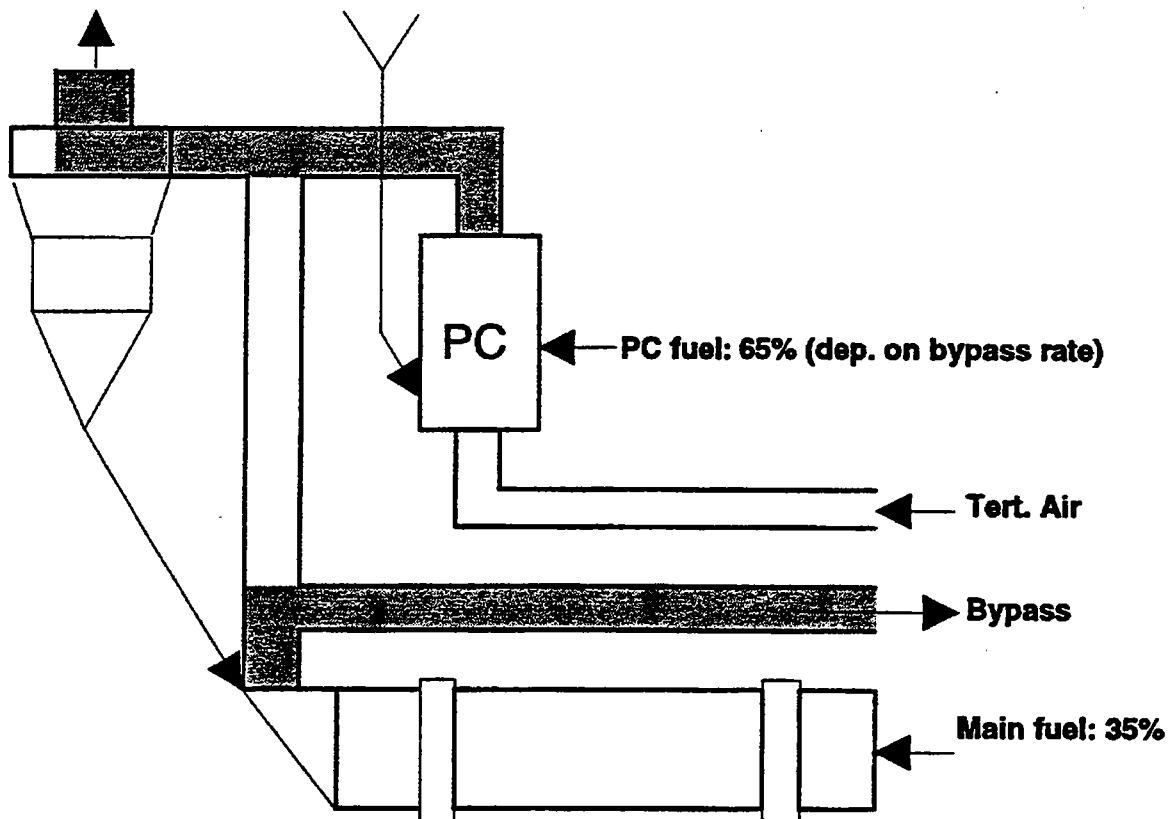

5. PRESENT STATE OF PRECALCINER DEVELOPMENT

5.1 Calciners from FCB

FCB have been IHI licensees since the mid seventies for in-line calciners resulting in 8 operating installations and 6 under construction. The highest capacity is 3300 t/d (Tourah, Egypt).

Together with Ciments Français FCB have designed a new type of calciner with low emissions suitable for low grade fuels called the FCB low NO_x PC (Fig. 12).

In combination with a low NO_x kiln burner, FCB expect to achieve 150 - 350 ppm NO_x at the stack with their new calciner. The first industrial prototype is scheduled for 1992.

The FCB calciner looks like a vertical reactor with one three channel burner on the top. Tertiary air is introduced from the top as well as with the meal on two sides. Flow is vertical from top to bottom. Meal can be proportioned via three points on two levels. FCB claim to achieve:

- ◆ Hot spot
- ◆ Reducing atmosphere zone → NO_x reduction
- ◆ Controlled flame
- ◆ No separation of coal and meal

5.2 Calciners from FLS - FULLER

The FLS range of calciners will be marketed by both FLS and FULLER.

Three basic air separate calciner systems are available: ILC, SLC-S and SLC (Fig. 13).

All these use a vessel type calciner which provides retention time by means of volume. Experiences with this system made no conceptual changes necessary.

The only modification to be mentioned is the new tangential tertiary air inlet for the ILC system which allows larger calciner volume without requiring more height.

Main features of the FLS calciner systems presently available are:

- ◆ Variable kiln orifice (Fig. 14) for the SLC-S calciner to control the ratio of secondary to tertiary air in place of the often troublesome damper in the tertiary air duct.
- ◆ Low NO_x version by splitting the tertiary air creating a controlled area of reducing atmosphere in the lower part of the PC which is horizontally divided in two zones by an orifice.
- ◆ Variation of the calciner outlet temperature with the SLC-S system without changing the preheater temperature profile providing a „temperature window“ for NH₃ injection.

5.3 PYROCLON Calciners (KHD)

The calciner systems by KHD (and Polysius) are based on the 1965 Dottenhausen „goose neck“ design, a tube type calciner. As PYROCLON-R, a whole range of versions has been developed (Fig. 15).

A low NO_x version of the RP version is not available. KHD tackle the problem of CO from incomplete combustion with coal firing by focusing on improved coal dosification.

Incomplete mixture of waste gases from kiln and calciner is often found with tube type calciners. In order to achieve a good mixture, an essential prerequisite for low NO_x systems using excess fuel zones in the precalciner, the 180°C elbow is substituted by a new reaction chamber, called PYROTOP (Fig. 16). A PYROCLON-R Low NO_x with PYROTOP allows:

- ◆ Complete combustion of the calciner fuel
- ◆ Temperature controlled zones (NH₃ injection)
- ◆ Improved mixing of gases
- ◆ Reduction of NO_x

5.4 PREPOL® Calciners (Polysius)

Polysius calciners are all of the air separate (AS) h-line-type. It is generally accepted today that the calcination process takes place within a few seconds making the fuel reactivity the decisive design criteria for the calciner size.

The „goose neck“-tube type calciner PREPOL by Polysius is presently available in three basic configurations (Fig. 17).

Several Polysius calciners have been modified by the company CLE who added an RSP type pre-combustion chamber. The same principle is now incorporated in the PREPOL AS-CC calciner by Polysius.

Polysius started in 1985 to develop their NO_x reducing technology called MSC based on experience available from power stations with staged combustion. They have adapted this method to the requirements of the clinker burning process. Trial operation on cement plants have shown 35 - 45% reduction of NO_x.

The idea is to create a limited zone of reducing atmosphere near the transition chamber by adding a small amount of fuel to the rotary kiln exhaust gas via a small burner in the riser duct. For the NO_x from the calciner fuel, the same principle is applied resulting in a second reducing zone. Such a system would have the following fuel inputs:

- ◆ < 50% main burner
- ◆ < 10% via primary DeNO_x burner
- ◆ > 30% via precalciner
- ◆ < 10% via secondary DeNO_x burner

Experience on an industrial scale only will prove the capability of this system. One of the difficulties is how to control the kiln atmosphere without the gas analysis sampled near the kiln inlet.

5.5 Prerov-Calciner

The Czek company Prerov have developed a new precalciner (Fig. 18). It consists of a precombustion chamber (KKS) and a reaction chamber (KKN) with a vortex chamber and is comparable to Polysius' PREPOL-AS CC. During 1992, the first installation will be commissioned in Southern Italy.

5.6 Conclusion

The development of tube type calciners and vessel type calciners has moved them closer to each other. The tube type calciners have received a swirl pot or a pre-combustion chamber for improved mixing and fuel burning and the vessel type calciners have become longer.

The calciner without separate air duct also known as „air through“ actually operating only with 10 - 20% of the total fuel never fulfilled the expectations and has virtually disappeared, together with the planetary cooler.

Low NOx calciners have been developed based on the principle of locally reducing atmosphere by means of fuel excess zones. It can be expected that NOx from precalciner combustion can be reduced to around 700 - 800 ppm. Calciners can be designed to reduce NOx generated in the burning zone, or to keep NOx generated in the calciner low, or both.

Since further NOx reduction to lower levels require methods such as NH₃ injection, temperature control is very important.

A modern calciner can be described as follows:

Type:	in-line with pre-combustion chamber
Fuel ratio:	50 - 60% (include. low NOx fuel in case of staged combustion)
Fuel dosing:	low fluctuation
Fuel types:	various, including alternative fuels
Combustion environment:	pure air or air/kiln gas mix
Calciner size criteria:	fuel reactivity gas retention time (up to 4 - 5 sec.)
Feature:	enhanced turbulence
Tertiary air:	staged for reducing zone

6. SYNOPSIS OF PRECALCINERS

The different PC systems as well as their developers and suppliers are summarized in Table 3. During the 1970ies the cement manufacturers greatly contributed to the development of the Japanese PC systems:

Until 1985, of 304 kilns with PC, 83 were located in Japan, totaling 35% of the capacity. This shows the explosive expansion of PC systems in Japan back than. Today, all new kilns have precalciner with tertiary air duct.

Table 3 Synopsis of PC Systems

Trade Name	Signification	Developer & Licenser	Plant Supplier & Licensee
PASEC		Voert Alpine / SKET	ACT
SLC	Separate Line Calciner	F.L. Smidth	F.L. Smidth
SLC-S	Separate Line Calciner Special		
ILC	In-Line Calciner		
ILC-D	In-Line Calciner Downdraft		
ILC-E*	In-Line Calciner, Excess Air		
Prepol AS	Air Separate	Krupp-Polysius	Krupp-Polysius
Prepol AS-CC	Controlled Combustion		
Prepol AS-MS	Multi Stage Combustion		
Prepol AT*	Air Through		
Pyroclon R	Regular = Air Separate	KHD Humboldt Wedag	KHD Humboldt Wedag
Pyroclon RP	Regular Parallel		
Pyroclon R Low NOx			
Pyroclon R Low Nox with Pyrotop			
Pyroclon S*	Special = Air Through		
EVS-PC (only fuel - oil)	Echangeur à voie sèche avec précalcination	Fives-Cail Babcock	Fives-Cail Babcock
KKS-KKN	n.a.	Prero	Prerov
SF	Suspension Flash Calciner	Ishikawajima-Harima Heavy Ind. Chichibu Cement	Ishikawajima-Harima Heavy Ind. Fuller Company / Fives-Cail Babcock
NSF	New SF		
RSP	Reinforced Suspension Preheater	Onoda Cement	Onoda Engineering & Consulting Kawasaki Heavy Industries Allis-Chalmers CLE-Technip
KSV	Kawasaki Spouted Bed and Vortex Chamber	Kawasaki Heavy Industries	Kawasaki Heavy Industries
NKSV	New KSV		
MFC	Mitsubishi Fluidized Calciner	Mitsubishi Mining & Cement	Mitsubishi Heavy Industries
GG	Reduction Gas Generator	Mitsubishi Heavy Industries	
DDF	Dual Combustion and Denitration Furnance	Nihon Cement	Kobe Steel
CSF (CFF)	Chichibu Suspension Flash Calciner	Chichibu Cement	Chichibu Cement (own plants)
SCS	Sumitomo Cross Suspension Preheater and Spouted Furnace Process	Sumitomo Cement	Kawasaki Heavy Industries Ishikawajima-Harima Heavy Industries

*Air through: secondary firing systems

7. TEST QUESTIONS

- 1) Which is the chemical reaction with the highest heat consumption within the clinker burning process? How much does it consume in absolute terms (kJ/kg clinker) and in percent of the total heat consumption of a modern kiln system?
- 2) Which are the three basic precalciner arrangements and what are their differences?
- 3) At what temperature does the calcination take place and how much CO₂ is totally dissociated from the CaCO₃?
- 4) Which are the benefits of precalciner technology?
- 5) Which is the most important design criteria for precalciner dimensioning?
- 6) Explain the term „apparent calcination degree“. How can it be determined and what is its significance?
- 7) How do the effects of a bypass compare in case of a straight preheater kiln and a precalciner kiln?

Fig. 1 Sketch of Dotternhausen Kiln, the first Precalciner (KHD, 1966)

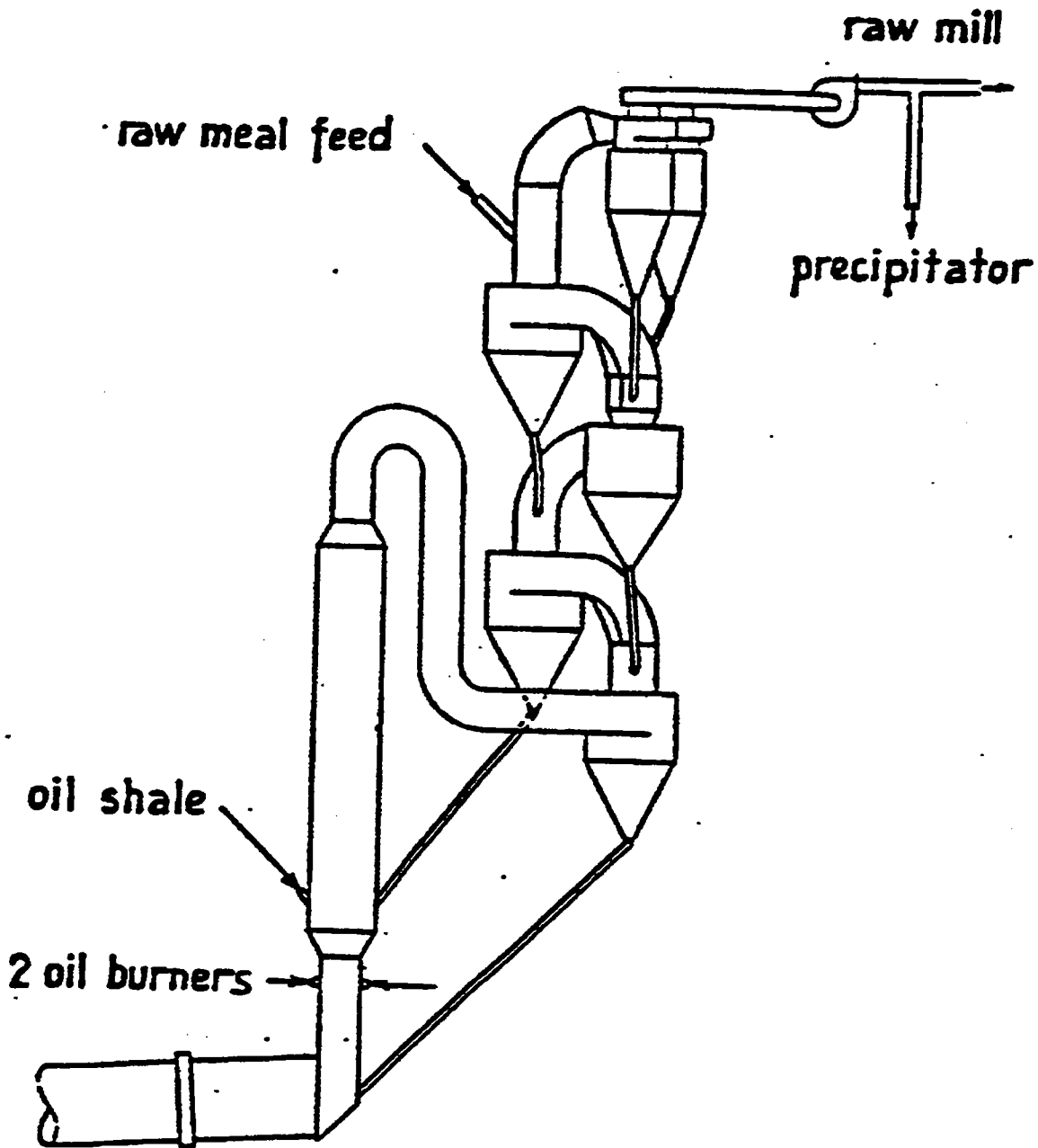

Table 4: Temperatures and Process Steps for Clinker Burning

Temperature [°C]	Process Step, Type of Reaction	Heat
20 - 100	Evaporation of free H ₂ O	Endo
100 - 300	Loss of physically absorbed H ₂ O	Endo
400 - 900	Removal of structural water	Endo
> 500	Structural changes in silicate minerals	Exo
600 - 900	Dissociation of CO₂ from CaCO₃	Endo
> 800	Formation of intermediate products Belite, Aluminate and Ferrite	Exo
> 1250	Formation of liquid phase (aluminate and ferrite melt)	Endo
	Formation of alite	Exo
1300 - 1240	Crystallization of liquid phase into mainly aluminate and ferrite	Exo

For numerical calculations, an approximate quantity of CO₂ from the raw material (dissociated from the calcites) can be used, regardless of the exact chemical composition.

CO₂ from raw mat = 0.28 Nm³/kg cli

Table 5: Energy Balance of Process Steps for Clinker Burning

Endothermic Processes:	kJ/kg cli	kcal/kg cli
Dehydration of clays	165	40
Decarbonisation of calcite	1990	475
Heat of melting	105	25
Heating of raw materials (0 to 1450°C)	2050	490
Total endothermic	4310	1030
Exothermic Processes:	kJ/kg cli	kcal/kg cli
Recrystallization of dehydrated clay	40	10
Heat of formation of clinker minerals	420	100
Crystallization of melt	105	25
Cooling of clinker	1400	335
Cooling of CO ₂ (ex calcite)	500	120
Cooling and condensation of H ₂ O	85	20
Total exothermic	2550	610
Net Theor. Heat of Clinker Formation:	kJ/kg cli	kcal/kg cli
Endothermic - exothermic	1760	420

Heat consumption of Kiln System:	kJ/kg cli	kcal/kg cli
Average 4-stage SP system	3300	790
Modern 6-stage SP system	3000	720
Rel. Heat Requirement of Calcination:		
Average 4-stage SP system	60%	
Modern 6-stage SP system	66%	

Fig. 12 FCB Low-NO_x Precalciner

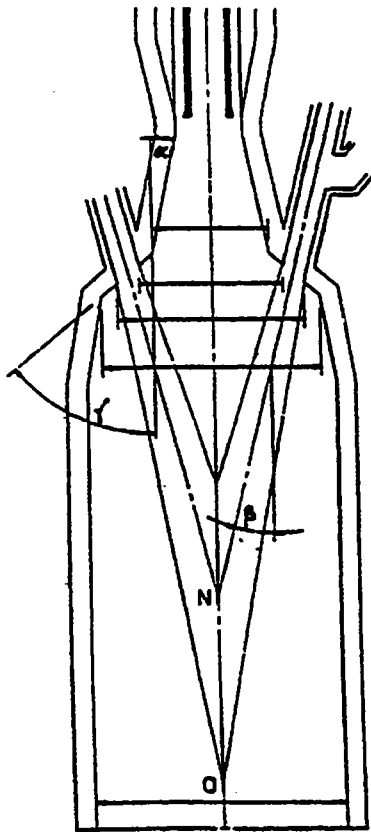

FCB LOW-NO_x PRECALCINER

- | | | |
|------------------------------------|---|--------------------------------|
| A High-performance burner | ↔ | Ignition of all fuels |
| A reducing first zone | ↔ | Low NO _x production |
| A controlled mixing in the reactor | ↔ | Better burn out |

Fig. 13 FLS

FLS F. L. SMITH

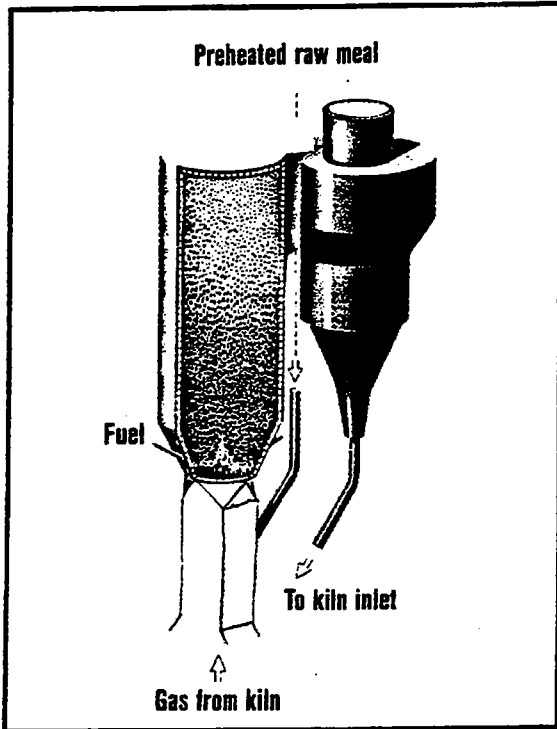

ILC-E calciner.

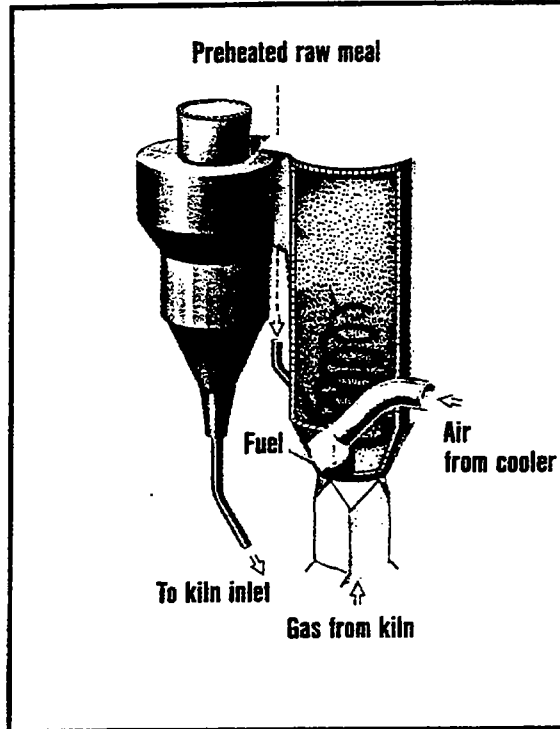

ILC calciner.

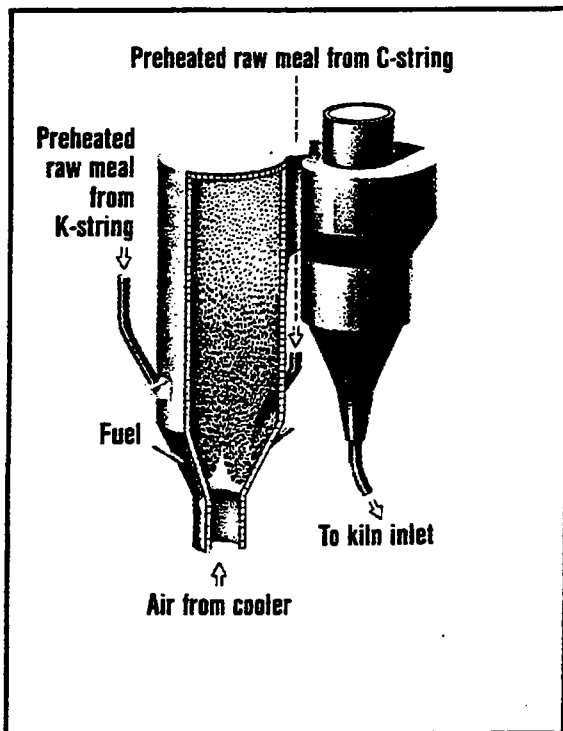

SLC calciner.

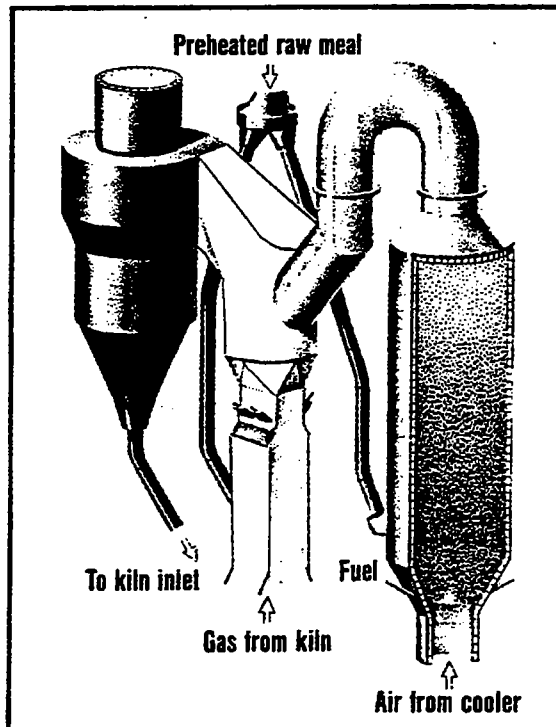

SLC-S calciner.

Fig. 14 FLS Adjustable Kiln Orifice

FLS F. L. SMITH

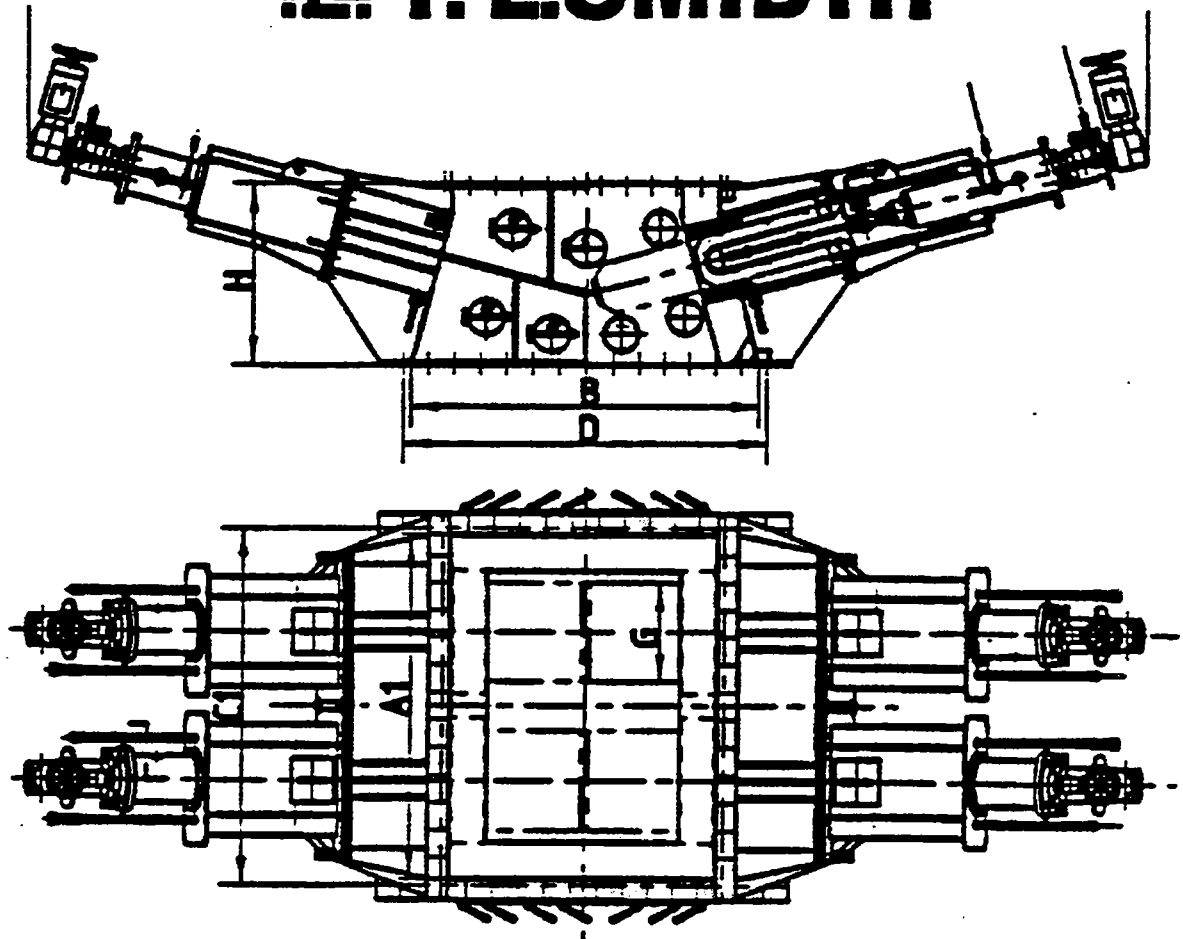

ADJUSTABLE KILN ORIFICE

Fig. 15 Pyroclon

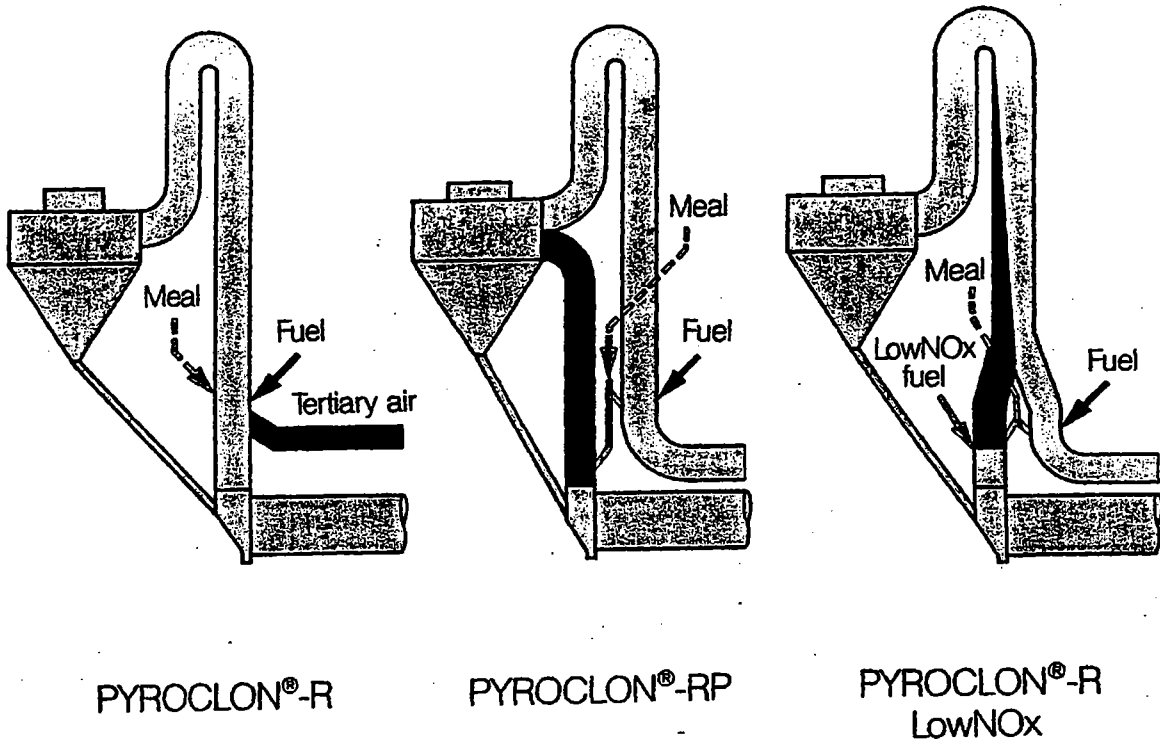
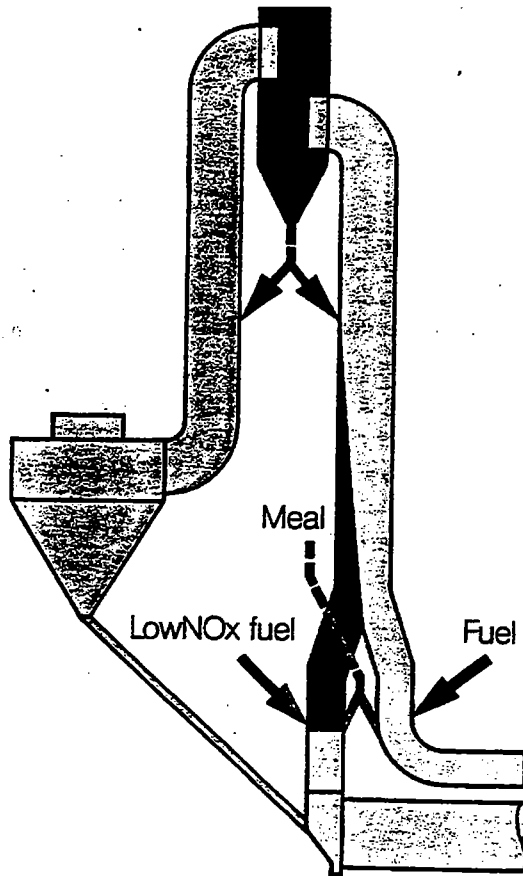
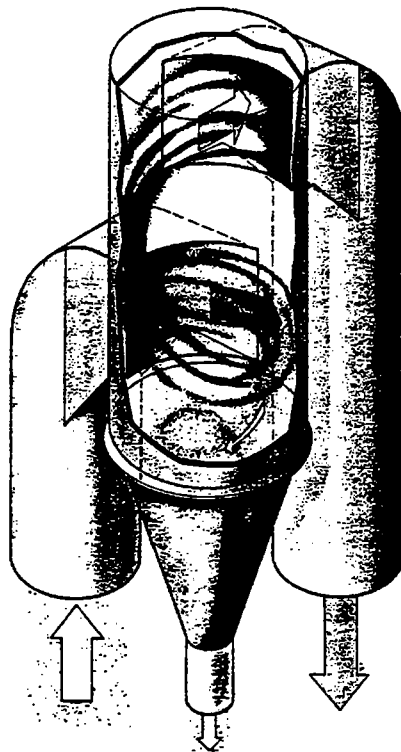

Fig. 16 Pyrotop



PYROTOP-calciner



*Flow pattern in
PYROTOP-calciner*

Fig. 17 Polysius

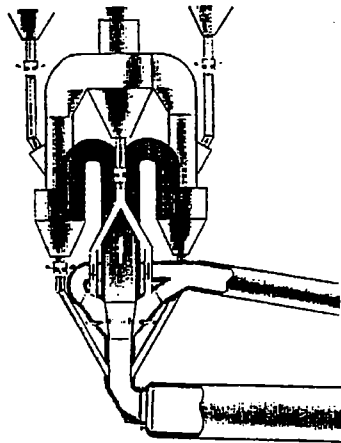

PREPOL®-AS

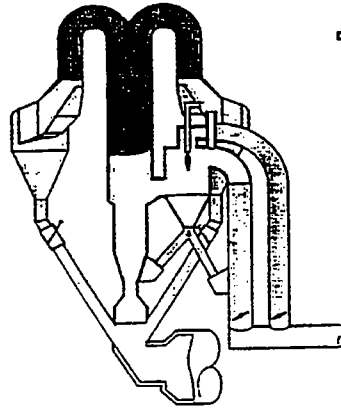

PREPOL®-AS-CC

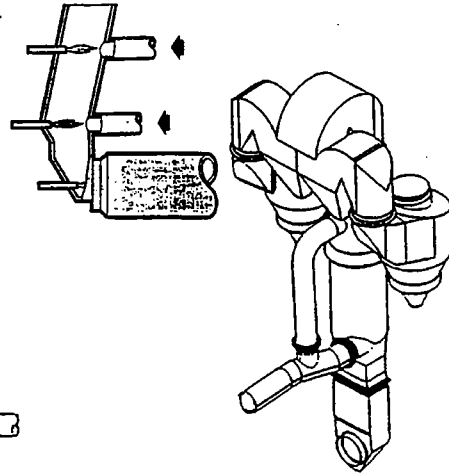

PREPOL®-MSC
Multi-stage-combustion

Polysius calciners



Fig. 18 Prerov

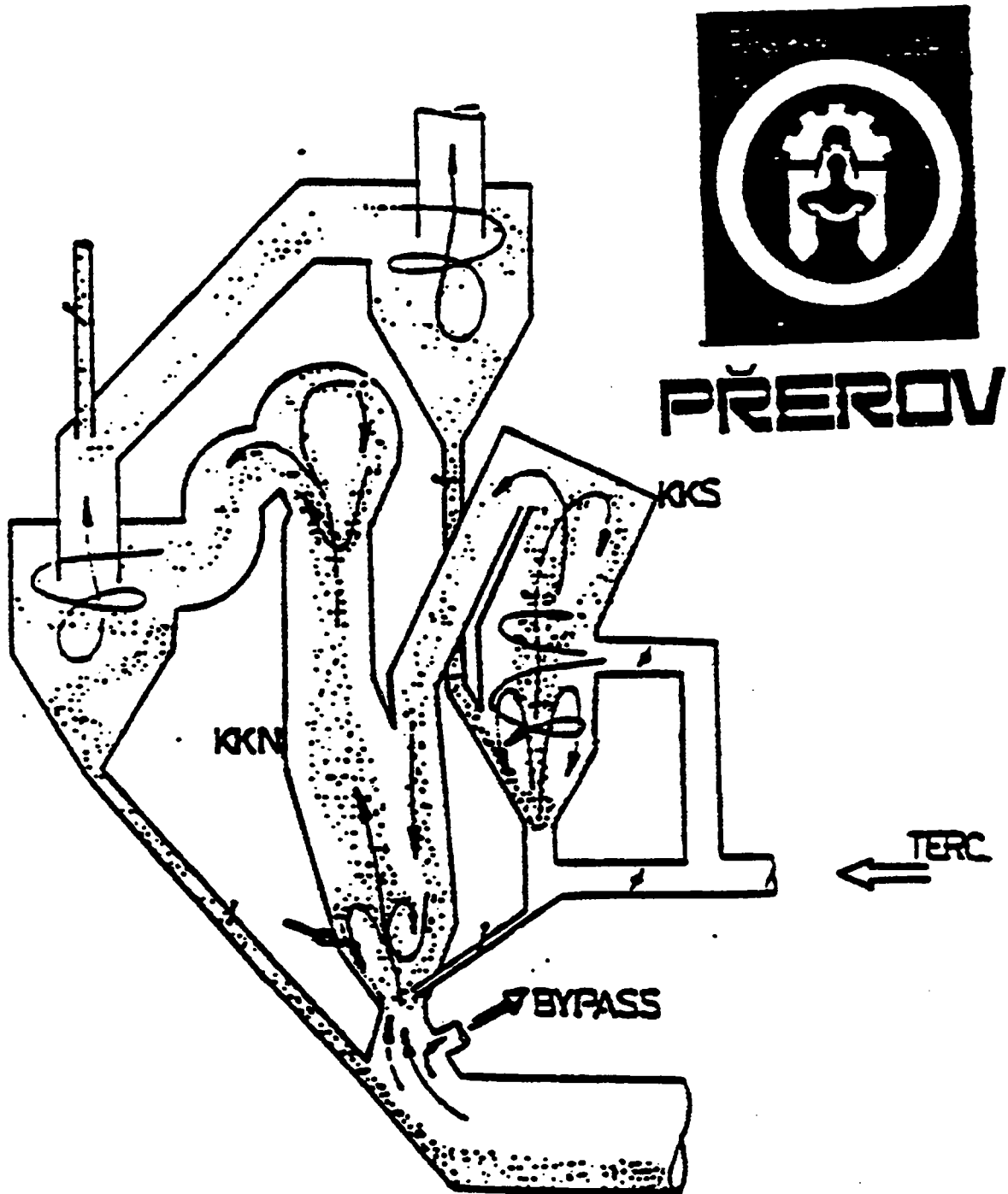
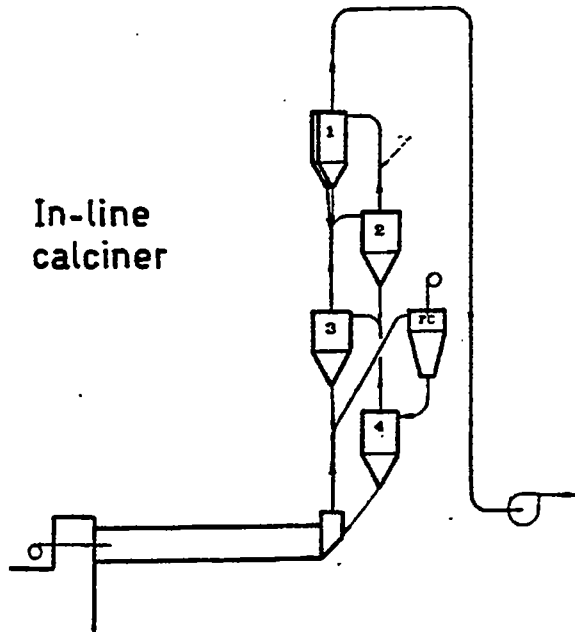
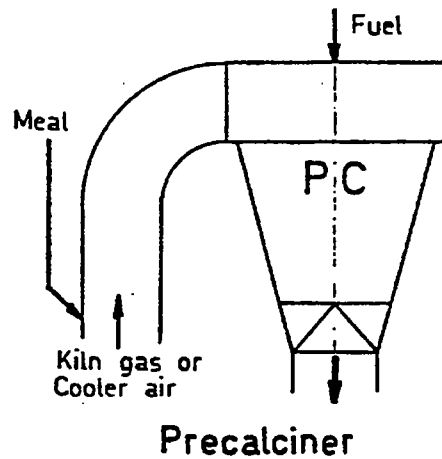

Fig. 19 EVS-PC



In-line calciner



Precaliner

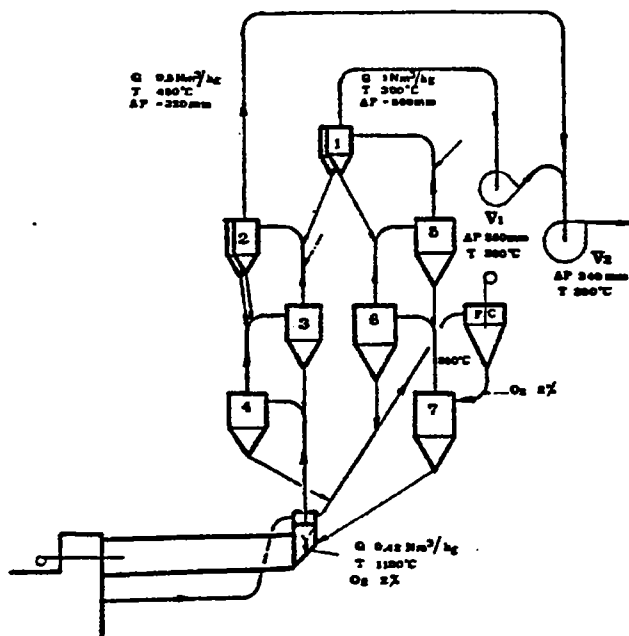

Separate-line calciner

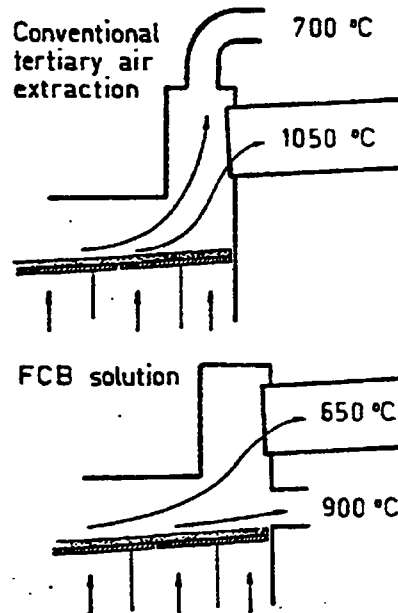

Tertiary air extraction

Features of EVS-PC PC system

Supplier: Fives-Cail Babcock

Fig. 20 SF / NSF

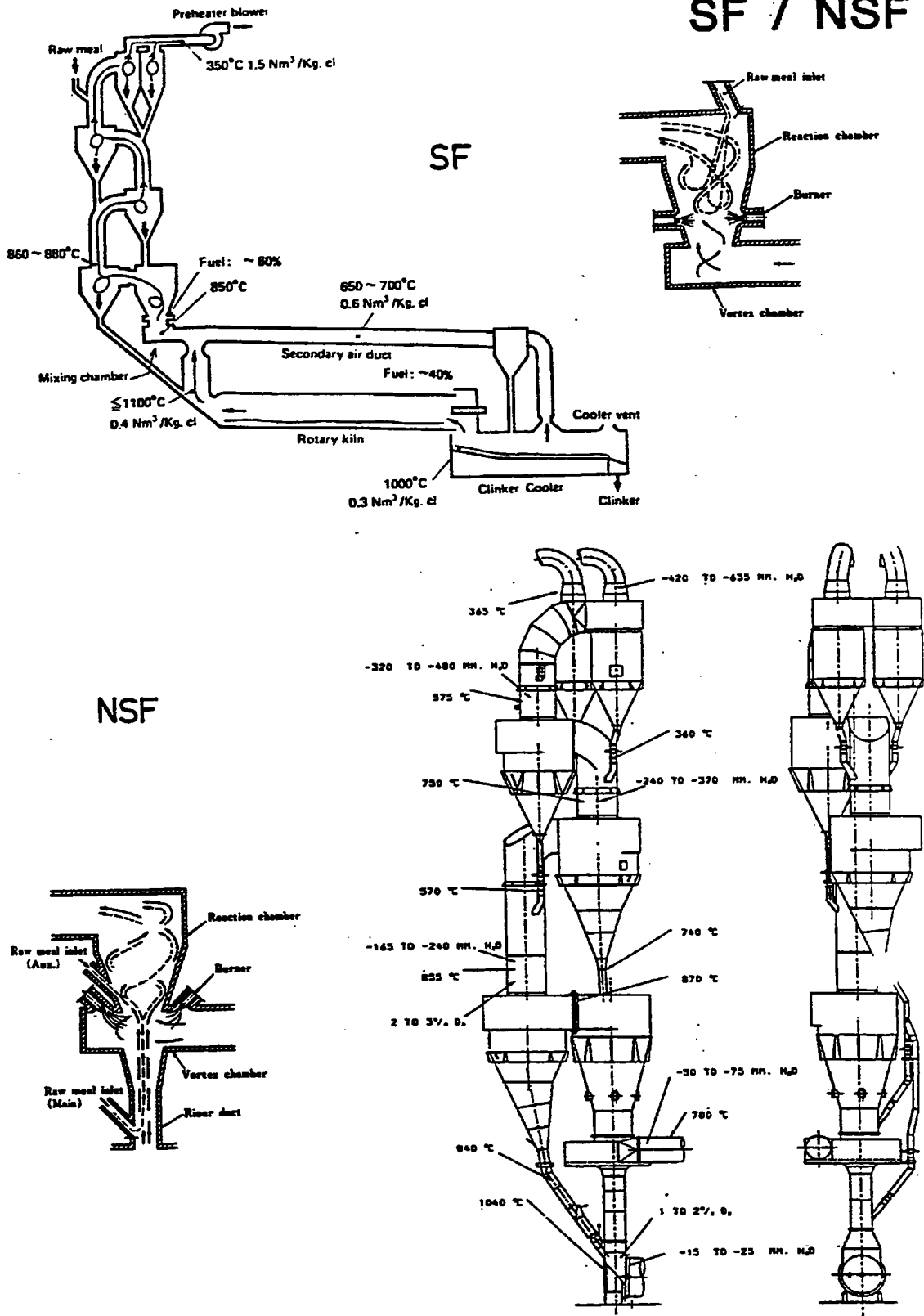

Features of SF/NSF PC system
 Suppliers: Ishikawajima-Harima Heavy Industries
 Fuller Company
 Fives-Cail Babcock

Fig. 21 RSP

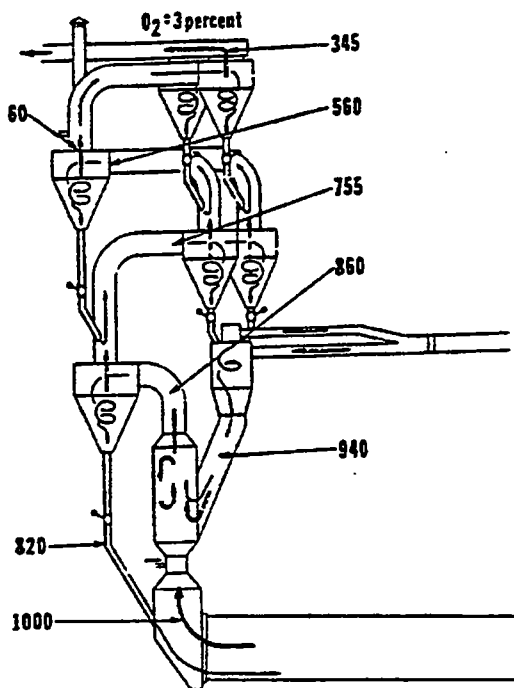

Gas Temperatures °C

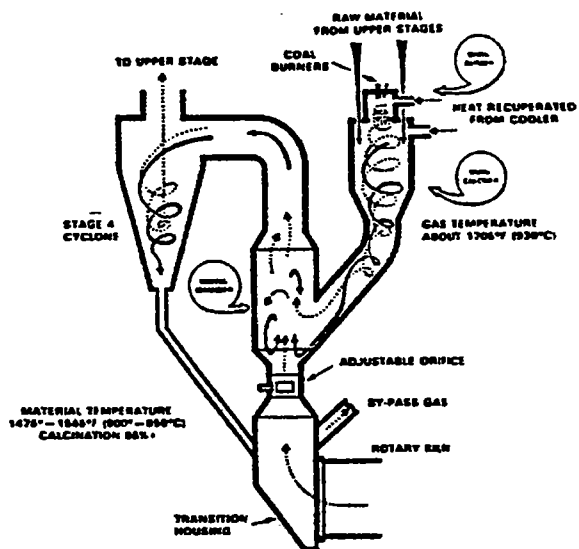

Precalciner

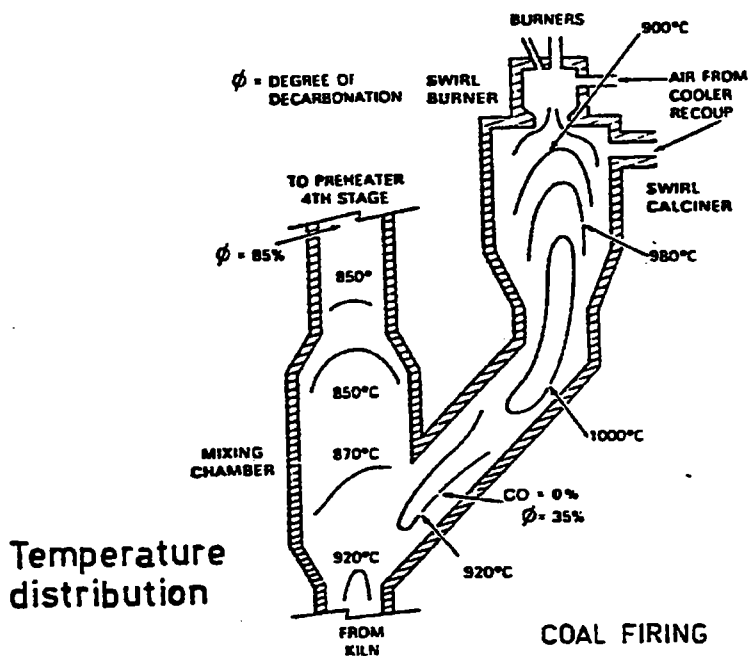

Features of RSP PC system

Suppliers: Onoda Engineering & Consulting
 Kawasaki Heavy Industries
 Allis Chalmers
 Creusot - Loire Entreprises

Fig. 22 KSV / NKSV

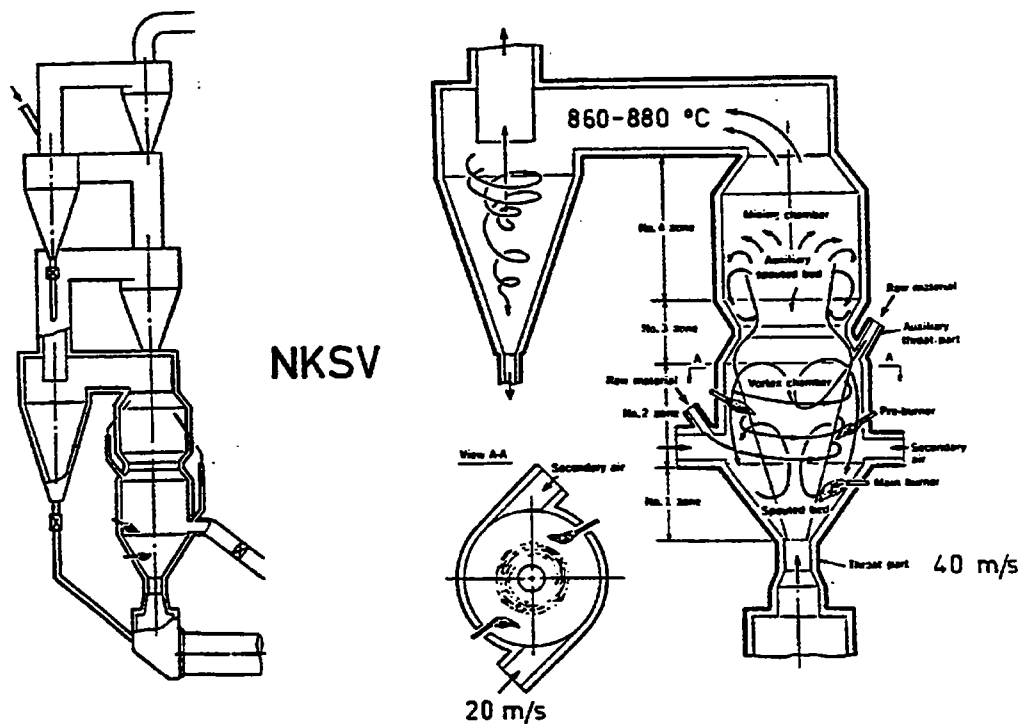
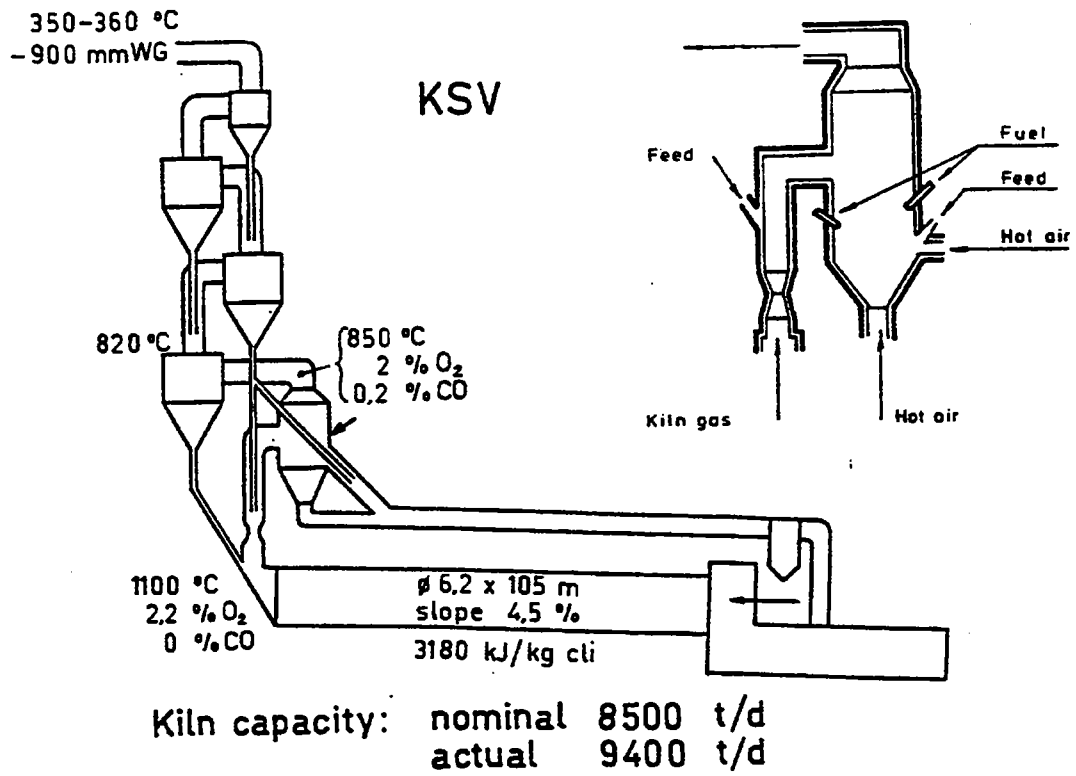

Features of KSV/NKSV PC system

Supplier: Kawasaki Heavy Industries

Fig. 23 MFC

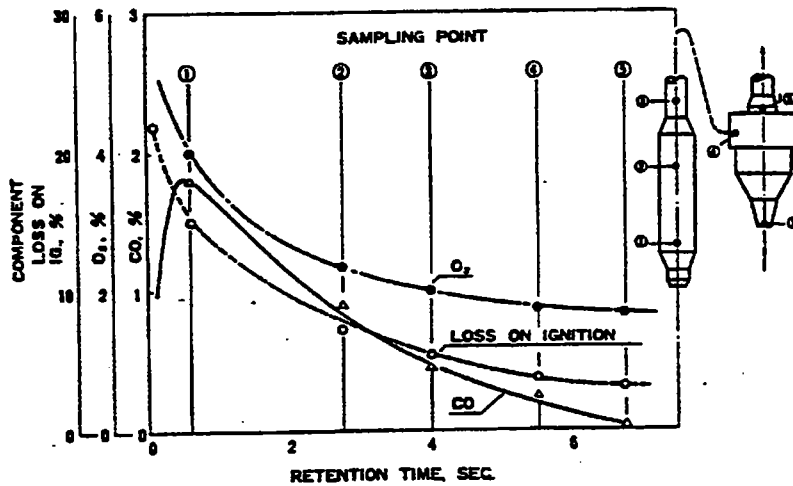
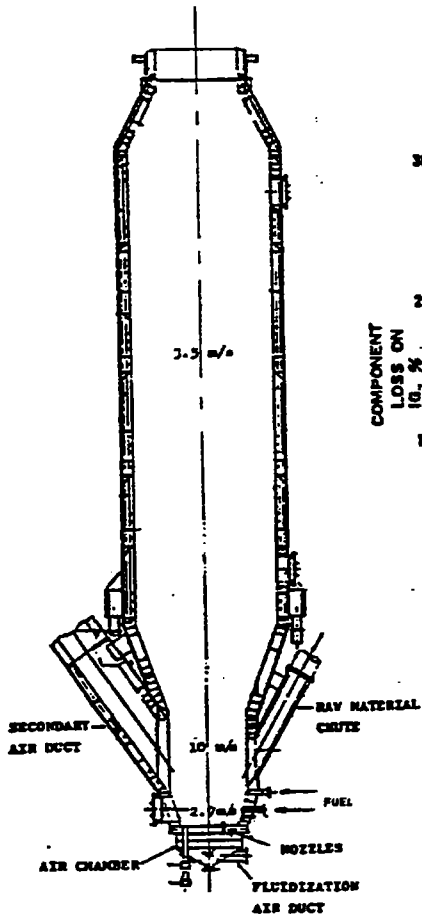
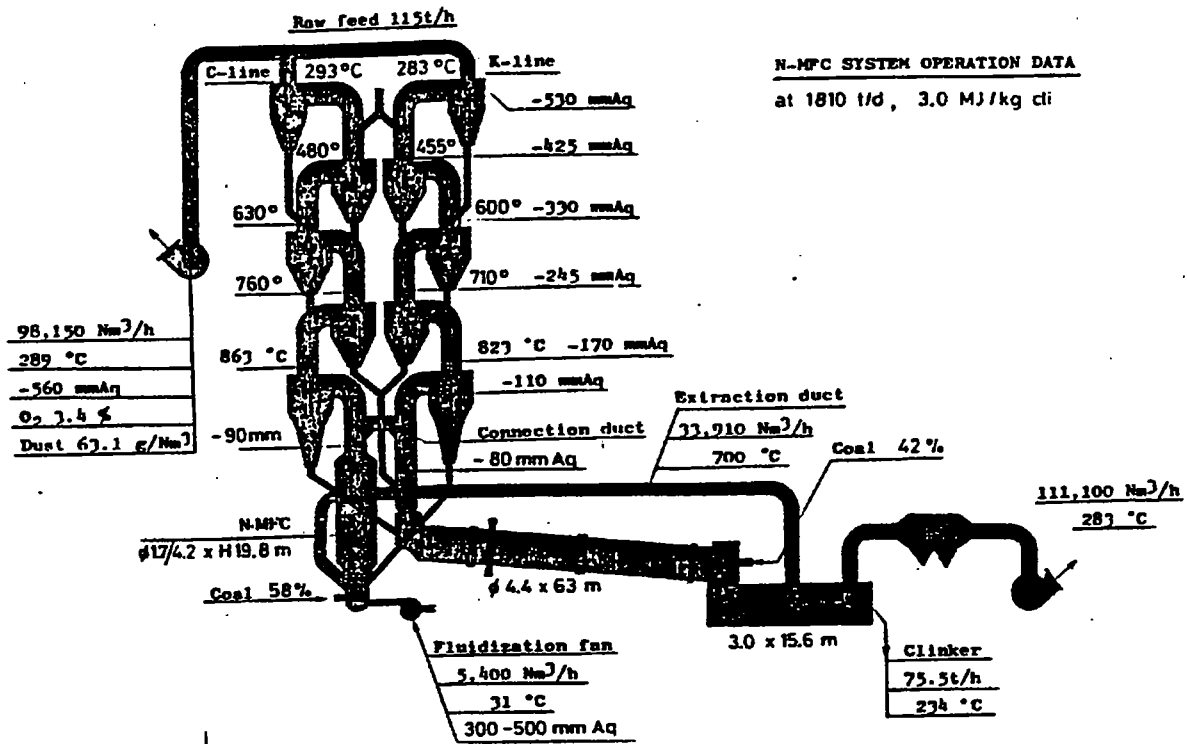

Features of MFC PC System
 Supplier: Mitsubishi Heavy Industries

Fig. 24 GG

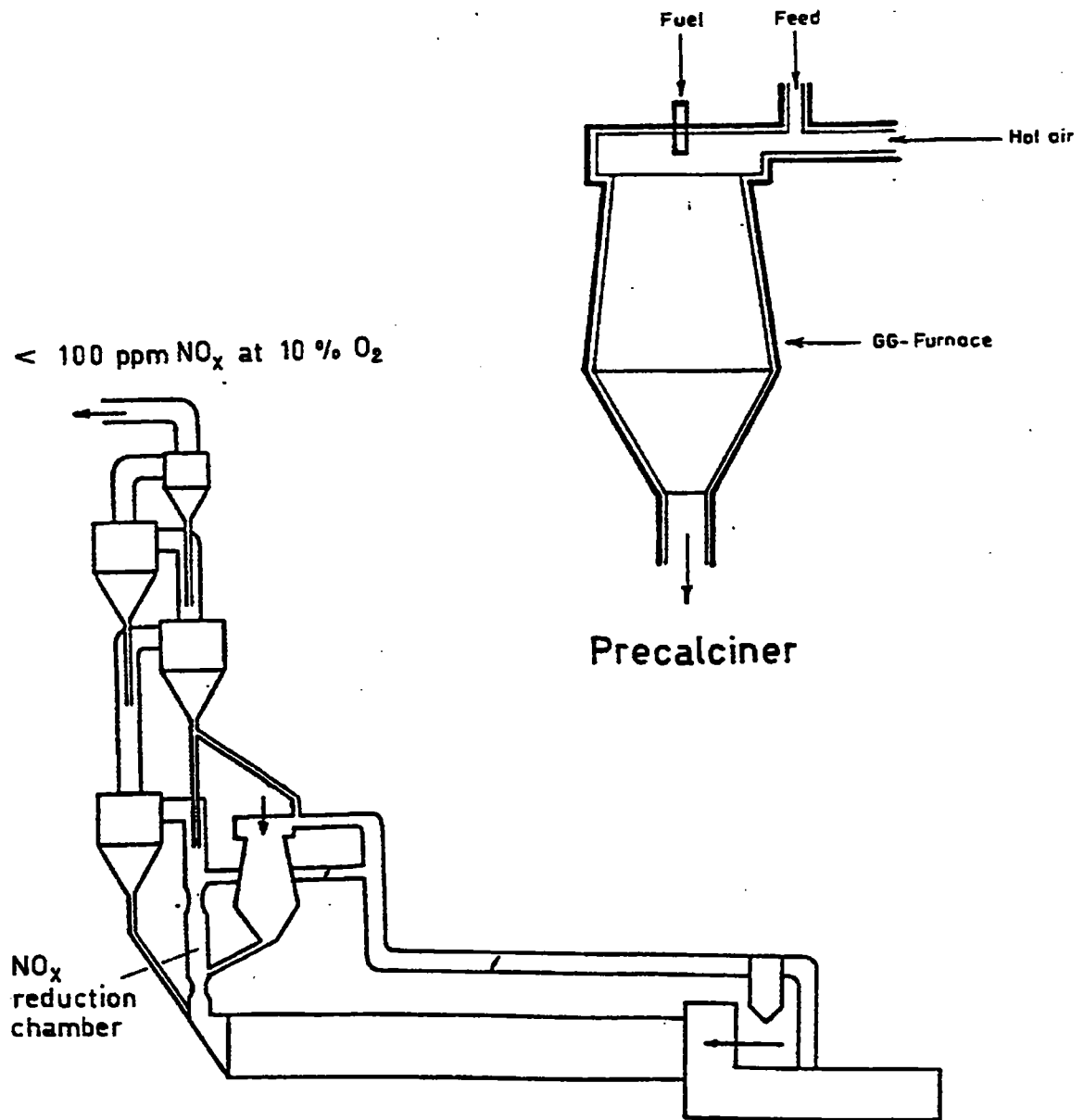

General arrangement

Features of GG PC system

Supplier: Mitsubishi Heavy Industries
System abandoned

Fig. 25 DD

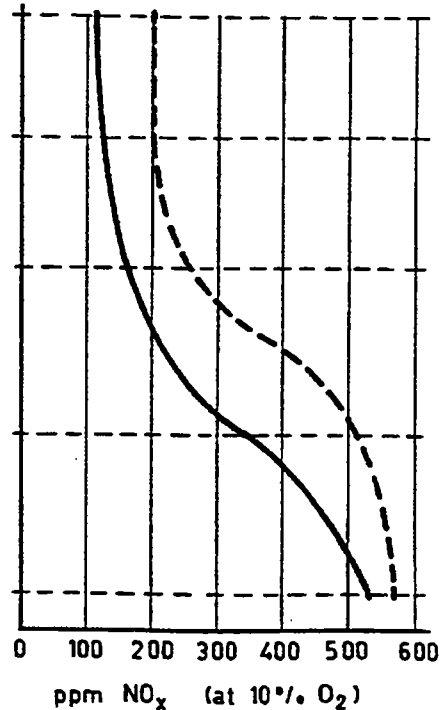
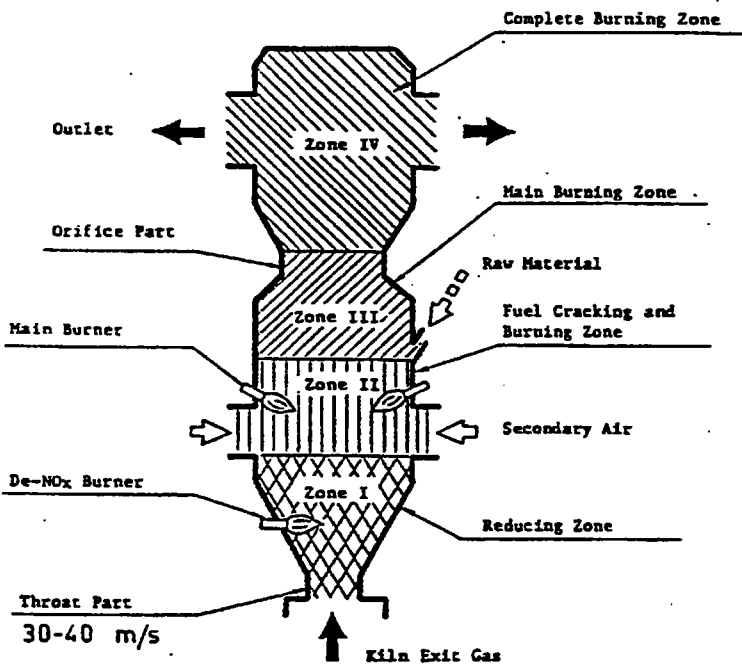
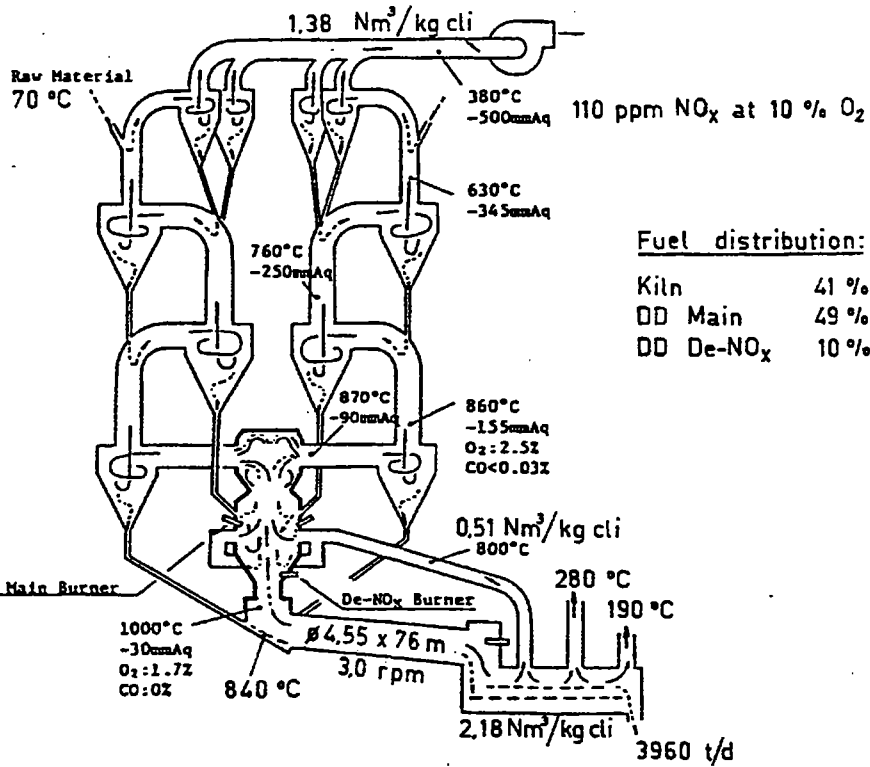

Features of DD PC System
 Supplier: Kobe Steel

Fig. 26 CSF

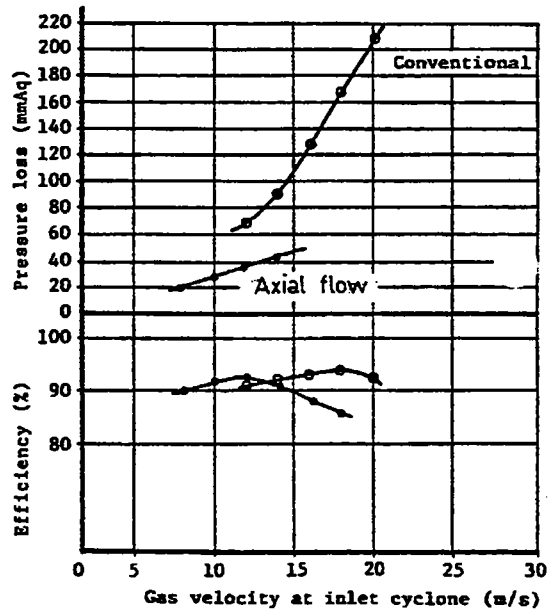
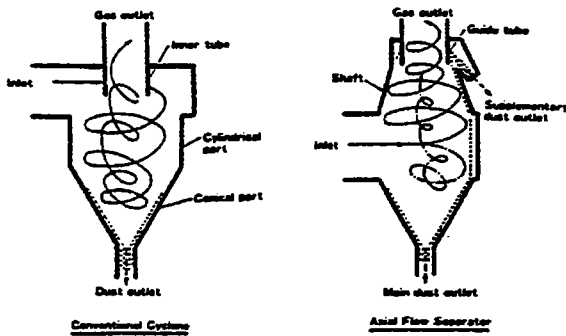
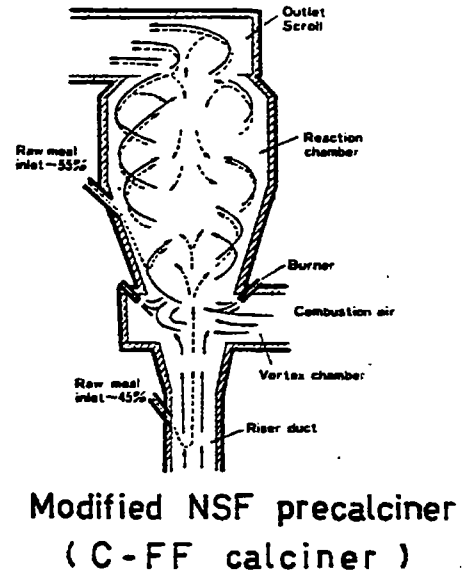
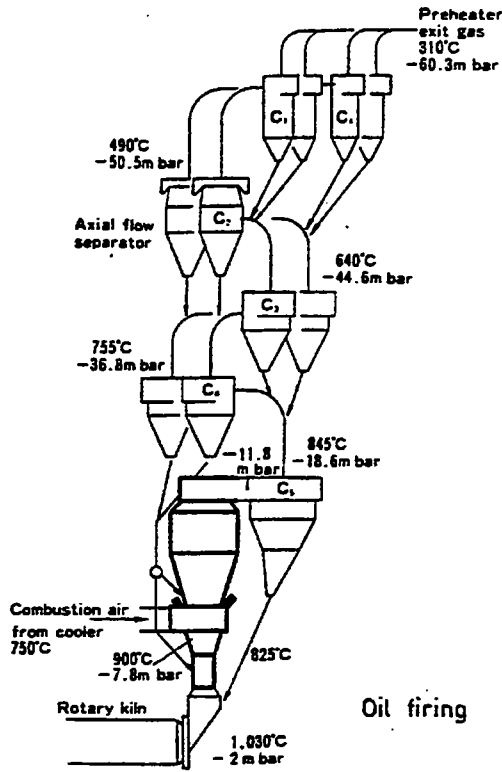

Features of CSF PC system

Supplier: Chichibu Cement in own plants

Fig. 27 Voest Alpine PASEC System

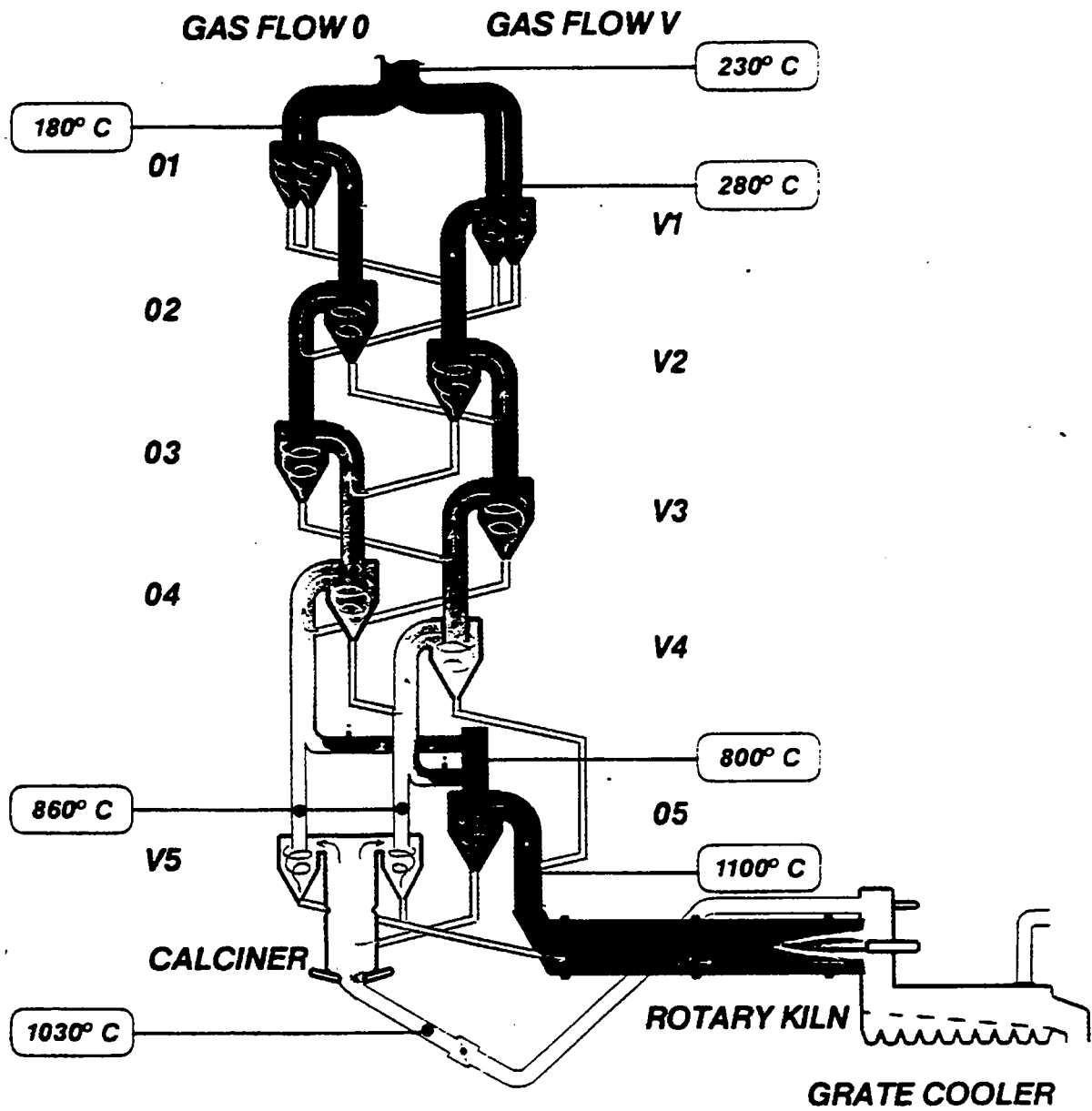
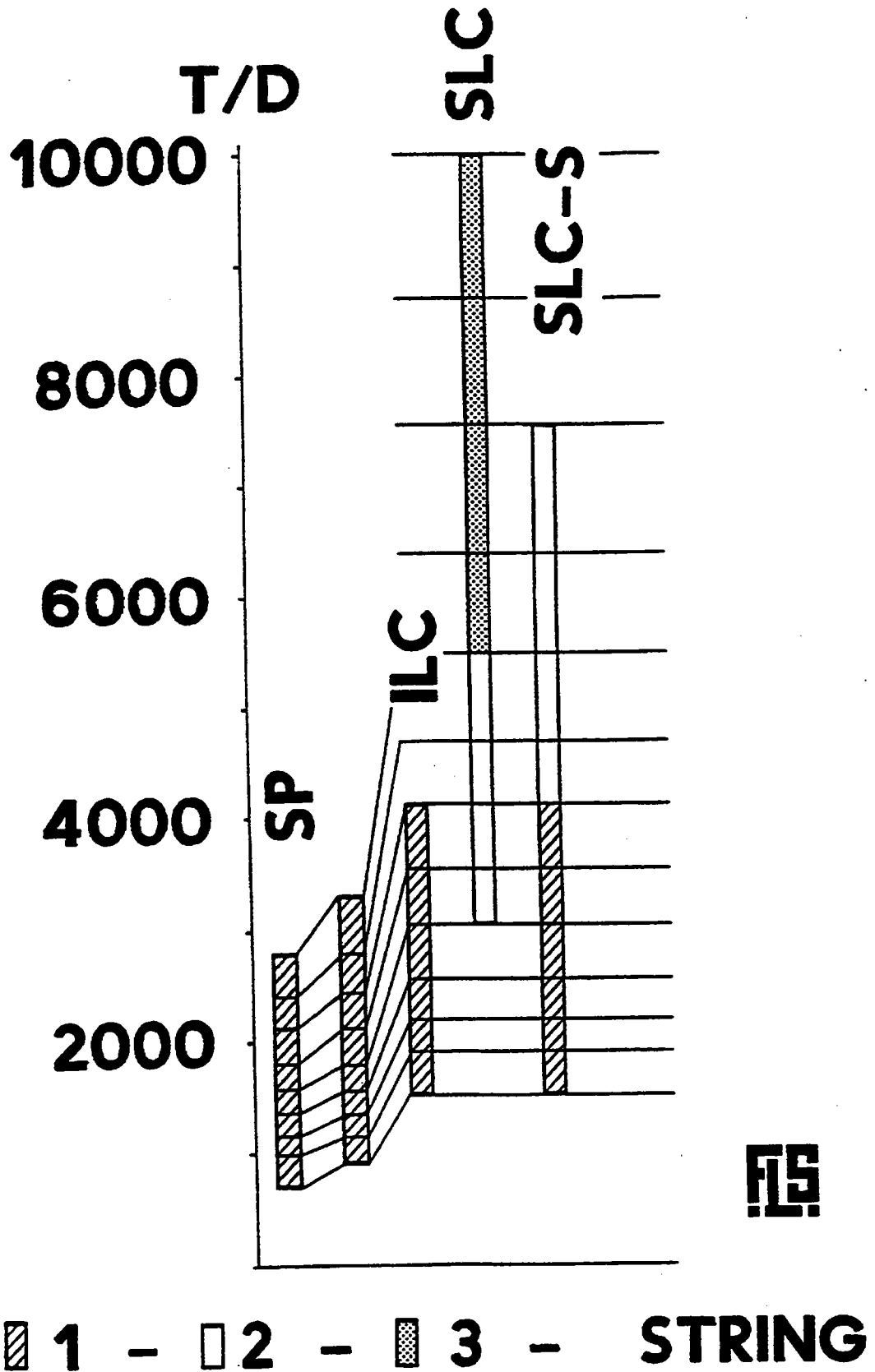

Fig. 28 FLS



FLS

